

DPX-1000

Digital Cinema Projector

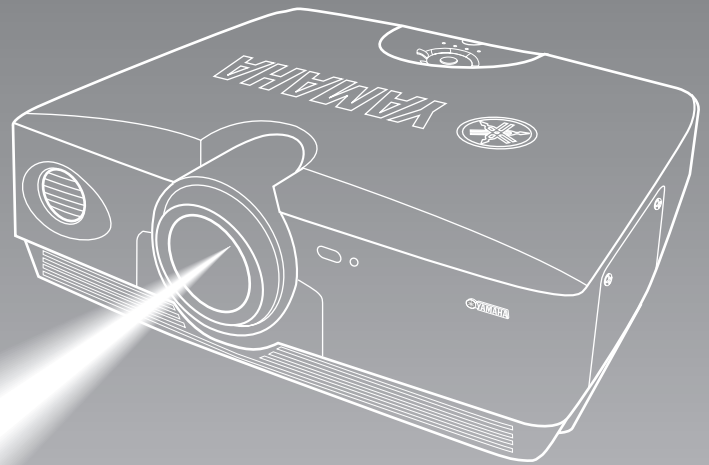

IMPORTANT SAFETY INSTRUCTIONS

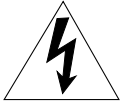

CAUTION

RISK OF ELECTRIC SHOCK
DO NOT OPEN



CAUTION: TO REDUCE THE RISK OF ELECTRIC SHOCK, DO NOT REMOVE COVER (OR BACK). NO USER-SERVICEABLE PARTS INSIDE. REFER SERVICING TO QUALIFIED SERVICE PERSONNEL.

• Explanation of Graphical Symbols

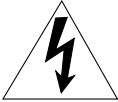

The lightning flash with arrowhead symbol, within an equilateral triangle, is intended to alert you to the presence of uninsulated “dangerous voltage” within the product’s enclosure that may be of sufficient magnitude to constitute a risk of electric shock to persons.



The exclamation point within an equilateral triangle is intended to alert you to the presence of important operating and maintenance (servicing) instructions in the literature accompanying the appliance.

WARNING

TO REDUCE THE RISK OF FIRE OR ELECTRIC SHOCK, DO NOT EXPOSE THIS UNIT TO RAIN OR MOISTURE.

IMPORTANT!

Please record the serial number of this unit in the space below.

Model:

Serial No.:

The serial number is located on the bottom of the unit.

Retain this Owner’s Manual in a safe place for future reference.

- 1 Read these instructions.
- 2 Keep these instructions.
- 3 Heed all warnings.
- 4 Follow all instructions.
- 5 Do not use this apparatus near water.
- 6 Clean only with dry cloth.
- 7 Do not block any ventilation openings. Install in accordance with the manufacturer’s instructions.
- 8 Do not install near any heat sources such as radiators, heat registers, stoves, or other apparatus (including amplifiers) that produce heat.
- 9 Do not defeat the safety purpose of the polarized or grounding-type plug. A polarized plug has two blades with one wider than the other. A grounding type plug has two blades and a third grounding prong. The wide blade or the third prong are provided for your safety. If the provided plug does not fit into your outlet, consult an electrician for replacement of the obsolete outlet.
- 10 Protect the power cord from being walked on or pinched particularly at plugs, convenience receptacles, and the point where they exit from the apparatus.
- 11 Only use attachments/accessories specified by the manufacturer.
- 12 Use only with the cart, stand, tripod, bracket, or table specified by the manufacturer, or sold with the apparatus. When a cart is used, use caution when moving the cart/apparatus combination to avoid injury from tip-over.
- 13 Unplug this apparatus during lightning storms or when unused for long periods of time.
- 14 Refer all servicing to qualified service personnel. Servicing is required when the apparatus has been damaged in any way, such as power-supply cord or plug is damaged, liquid has been spilled or objects have fallen into the apparatus, the apparatus has been exposed to rain or moisture, does not operate normally, or has been dropped.
- 15 Be sure to allow spaces of at least 30cm above, behind and on both sides the unit.
- 16 Do not place the following objects on this unit:
A vessel with water in it. If the vessel falls by vibrations and water spills, it may cause damage to the unit, and/or you may get an electric shock.



COMPLIANCE INFORMATION STATEMENT

(DECLARATION OF CONFORMITY PROCEDURE)

Responsible Party: Yamaha Electronics Corporation
Address: 6660 Orangethorpe Avenue
Buena Park, CA90620
Telephone: 714-522-9105
Fax: 714-670-0108
Type of Equipment: Projector
Model Name: DPX-1000

This device complies with Part 15 of the FCC Rules.

Operation is subject to the following conditions:

- 1) this device may not cause harmful interference, and
- 2) this device must accept any interference received including interference that may cause undesired operation.

See the user manual instructions if interference to radio reception is suspected.

FCC INFORMATION (for US customers only)

1. IMPORTANT NOTICE: DO NOT MODIFY THIS UNIT!

This product, when installed as indicated in the instructions contained in this manual, meets FCC requirements. Modifications not expressly approved by Yamaha may void your authority, granted by the FCC, to use the product.

2. IMPORTANT:

When connecting this product to accessories and/or another product use only high quality shielded cables. Cable/s supplied with this product MUST be used. Follow all installation instructions. Failure to follow instructions could void your FCC authorization to use this product in the USA.

3. NOTE:

This product has been tested and found to comply with the requirements listed in FCC Regulations, Part 15 for Class "B" digital devices. Compliance with these requirements provides a reasonable level of assurance that your use of this product in a residential environment will not result in harmful interference with other electronic devices.

This equipment generates/uses radio frequencies and, if not installed and used according to the instructions found in the users manual, may cause interference harmful to the operation of other electronic devices.

Compliance with FCC regulations does not guarantee that interference will not occur in all installations. If this product is found to be the source of interference, which can be determined by turning the unit "OFF" and "ON", please try to eliminate the problem by using one of the following measures:

Relocate either this product or the device that is being affected by the interference.

Utilize power outlets that are on different branch (circuit breaker or fuse) circuits or install AC line filter/s.

In the case of radio or TV interference, relocate/reorient the antenna. If the antenna lead-in is 300 ohm ribbon lead, change the lead-in to coaxial type cable.

If these corrective measures do not produce satisfactory results, please contact the local retailer authorized to distribute this type of product. If you can not locate the appropriate retailer, please contact Yamaha Electronics Corp., U.S.A. 6660 Orangethorpe Ave, Buena Park, CA 90620.

The above statements apply ONLY to those products distributed by Yamaha Corporation of America or its subsidiaries.

We Want You Listening For A Lifetime

YAMAHA and the Electronic Industries Association's Consumer Electronics Group want you to get the most out of your equipment by playing it at a safe level. One that lets the sound come through loud and clear without annoying blaring or distortion – and, most importantly, without affecting your sensitive hearing. Since hearing damage from loud sounds is often undetectable until it is too late, YAMAHA and the Electronic Industries Association's Consumer Electronics Group recommend you to avoid prolonged exposure from excessive volume levels.



Caution: Read this before operating this unit.

- To assure the finest performance, please read this manual carefully. Keep it in a safe place for future reference.

Installation

- Install this unit in a well-ventilated, cool, dry, clean place with at least 30 cm (1 feet) clearance on the top, right and left, and at the back of this unit — away from direct sunlight, heat sources, vibration, dust, moisture, and/or cold.
- Locate this unit away from other electrical appliances, motors, or transformers to avoid humming sounds. To prevent fire or electrical shock, do not place this unit where it may get exposed to rain, water, and/or any type of liquid.
- Do not expose this unit to sudden temperature changes from cold to hot, and do not locate this unit in an environment with high humidity (i.e. a room with a humidifier) to prevent condensation inside this unit, which may cause an electrical shock, fire, damage to this unit, and/or personal injury.
- On the top of this unit, do not place:
 - Other components, as they may cause damage and/or discoloration on the surface of this unit.
 - Burning objects (i.e. candles), as they may cause fire, damage to this unit, and/or personal injury.
 - Containers with liquid in them, as they may cause electrical shock to the user and/or damage to this unit.
- Do not cover this unit with a newspaper, tablecloth, curtain, etc. in order not to restrict heat dissipation. If the temperature inside this unit rises too much, it may cause fire, damage to this unit, and/or personal injury.
- When installing this unit on the ceiling, make sure the ceiling has sufficient strength to support this unit and the ceiling mounts for an extended period of time. Installation must be performed only by qualified service personnel.

Operation

- Remove the lens cover before starting any operation of this unit to prevent the heat from staying around the lens. Operation with the cap on may cause damage to this unit.
- Do not plug in this unit to a wall outlet until all connections are complete.
- Only the voltage specified on this unit must be used. Using this unit with a higher voltage than specified is dangerous and may cause fire, damage to this unit, and/or personal injury. YAMAHA will not be held responsible for any damage resulting from use of this unit with a voltage other than that specified.
- Do not use force on switches, knobs and/or cords.
- Do not operate this unit upside-down. It may overheat, possibly causing damage.
- Take care of this unit so that no foreign objects and/or liquid drop inside this unit.
- To prevent damage by lightning, disconnect the power cord from the wall outlet during an electrical storm.
- Do not look into the lens while this unit is turned on. It may cause serious damage to your eyesight.
- Before moving this unit, press **STANDBY/ON** to set this unit in the standby mode, and disconnect the AC power plug from the wall outlet.
- Do not attempt to modify or fix this unit. Contact qualified YAMAHA service personnel when any service is needed. The cabinet should never be opened for any reason.

- When not planning to use this unit for a long period of time (i.e. vacation), disconnect the AC power plug from the wall outlet.
- When disconnecting the power cord from the wall outlet, grasp the plug; do not pull the cord.
- Be sure to read the “TROUBLESHOOTING” section on common operating errors before concluding that this unit is faulty.

Others

- Clean the lens carefully so as not to create any scratches by using a blower or lens paper.
- Replace the lamp when the LAMP warning indicator blinks in red after the lamp usage has exceeded 2000 hours. Follow the lamp replacement procedure described in this manual.

For U.K. customers

IMPORTANT

THE WIRES IN THIS MAINS LEAD ARE COLOURED IN ACCORDANCE WITH THE FOLLOWING CODE:

GREEN-AND-YELLOW:	EARTH
BLUE:	NEUTRAL
BROWN:	LIVE

As the colours of the wires in the mains lead of this apparatus may not correspond with the coloured markings identifying the terminals in your plug, proceed as follows:

The wire which is coloured GREEN-AND-YELLOW must be connected to the terminal in the plug which is marked by the letter E or by the safety earth symbol or coloured GREEN or GREEN-and-YELLOW.

The wire which is coloured BLUE must be connected to the terminal which is marked with the letter N or coloured BLACK.

The wire which is coloured BROWN must be connected to the terminal which is marked with the letter L or coloured RED.

If the socket outlets in the home are not suitable for the plug supplied with this appliance, it should be cut off and an appropriate 3 pin plug fitted. For details, refer to the instructions described below.

Note

- The plug severed from the mains lead must be destroyed, as a plug with bared flexible cord is hazardous if engaged in a live socket outlet.

For Canadian customers

To prevent electric shock, match wide blade of plug to wide slot and fully insert.

This Class B digital apparatus complies with Canadian ICES-003.

Inappropriate places for installation

If this unit is not correctly installed in an appropriate place, it may cause fire or failure, or damage the unit itself. Carefully choose the place to install this unit by avoiding the places listed below.

1. Places where the temperature and humidity vary greatly

- Do not install this unit in a place where the temperature and humidity become extremely high or the temperature becomes extremely low.
- This unit must be used within a temperature range of 5—35°C.

2. Places without adequate ventilation

- Install this unit with at least 30 cm (1 feet) of ventilation space on the top, right and left, and back.
- Do not cover the ventilation slots of this unit not to obstruct the heat dissipation.
- Install this unit on the firm surface.
- Do not cover this unit with a tablecloth, etc.
- Make sure there is nothing to get sucked into the ventilation slots so that the temperature of this unit does not become too high.
- If you are going to install the unit in a rack, be sure to leave space for ventilation to prevent exhaust overheating the unit.

3. Places where it gets dusty

- If the filter is blocked with dust, the temperature of this unit may become too high.

4. Places with too much vibration or impact

- Vibration and impact can damage parts of this unit.

5. Places where this unit gets exposed to water or high humidity

- If this unit is exposed to water or high humidity, it may cause a fire or electrical shock.

6. Unstable places

- If this unit is installed on an unstable or an inclined tabletop, it may fall and cause damage to the unit or personal injury.

7. In close proximity to a Radio or Stereo

- The unit may interfere with reception if placed in close proximity to a radio or television receiver.

Important

- To ensure vivid, high contrast images, make sure that no light other than the projector light falls directly on the screen.

Accessory check

Please check that all accessories listed here are included in your package.

- Remote control

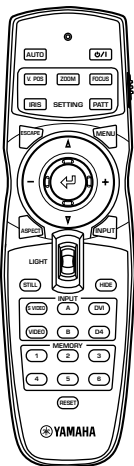

- Batteries (AA, UM-3 or R6)

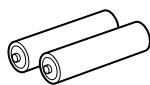

- Pin/BNC adapters



- Power cable

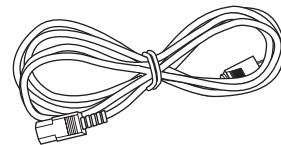

- Lens cover

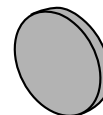

Features

- Bright, high contrast images achieved through DLP™ technology
- HDTV capable 1280 x 720 pixel wide DMD™ element
- A bright, high resolution large diameter lens
- Electronic lens adjustment — Zoom, Focus, Vertical Position, Optical Iris Diaphragm —
- Low operating noise made possible by Yamaha sound technology
- High quality progressive reproduction of film sources thanks to 3-2 pulldown detection
- 6 memory settings and an abundance of image adjustment functions
- Digital Visual Interface (DVI) HDCP Compatible

(DLP™ and DMD™ are trademarks of Texas Instruments.)

Contents

INTRODUCTION

Features	1
Part Names and Functions	
Front panel and controls	2
Connections	3
Remote control	4
Using the remote control	5
Loading the batteries into the remote control	5
Using the remote as a wired remote control	5

INSTALLATION

Installation

Installation methods	6
Screen and projection distance	7
Projection image position	8
Keystone	8

CONNECTIONS

Connecting the unit

Connecting A/V components	9
Connecting to a computer	10

BASIC OPERATION

Basic Operations

Turning on the power	11
Turning off the power	11
Preparations for projection	12
Select an input	13
Select a display aspect	14
Other functions	15
Indicators	15

MENU

Menu structure	16
① <IMAGE>	17
② <SIGNAL>	19
③ <INITIAL>	20
④ <SETUP>	21
Menu operation	
Menu screen and operating buttons	22
Basic menu operation	23
Submenus	24
Basic submenu operation	25
One-touch image menu	28
Changing the menu location	28
Memory function	
Selecting the memory setting number	29
Resetting to the factory default settings	30

ADDITIONAL INFORMATION

Additional information

Glossary	31
Projectable signals	33
Message display	34

Maintenance

Regular care	35
Filter replacement	35
Replacing the lamp cartridge	36

Troubleshooting 37

Specifications

Specifications	38
Dimensional drawing	39

Part Names and Functions

■ Front panel and controls

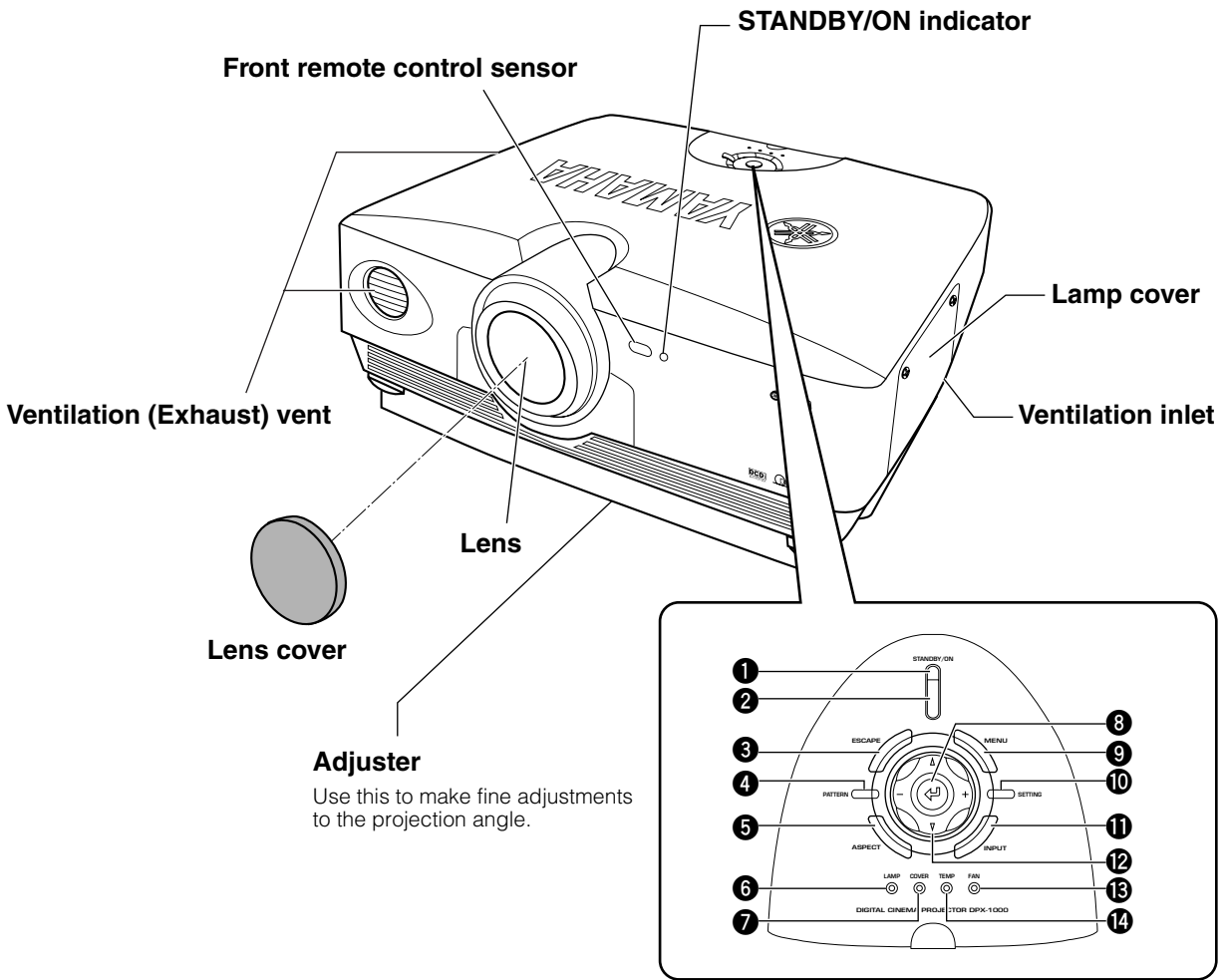

1 STANDBY/ON indicator

2 STANDBY/ON button

Switches the unit between Standby and On (operational) modes.

3 ESCAPE button

Use this button to exit from submenu mode.

4 PATTERN button

Switches the built-in test pattern display on and off.

5 ASPECT button

Selects the display aspect of the projection image. Press the button to display the aspect presently being used. Pressing the button again within 2 seconds will switch the unit to the next aspect mode.

6 LAMP warning indicator

7 COVER warning indicator

8 (Enter) button

Press this button to set values and enter into submenus.

9 MENU button

Press this button to display the general settings and adjustments menu.

10 SETTING button

Selects the various lens adjustment modes.

11 INPUT button

Press this button to display the input source and input signal selection menu.

12 Cursor button

Use the Δ , ∇ , $-$, $+$ buttons for functions such as system operations, menu item selection, and changing system values.

13 FAN warning indicator

14 TEMP warning indicator

■ Connections

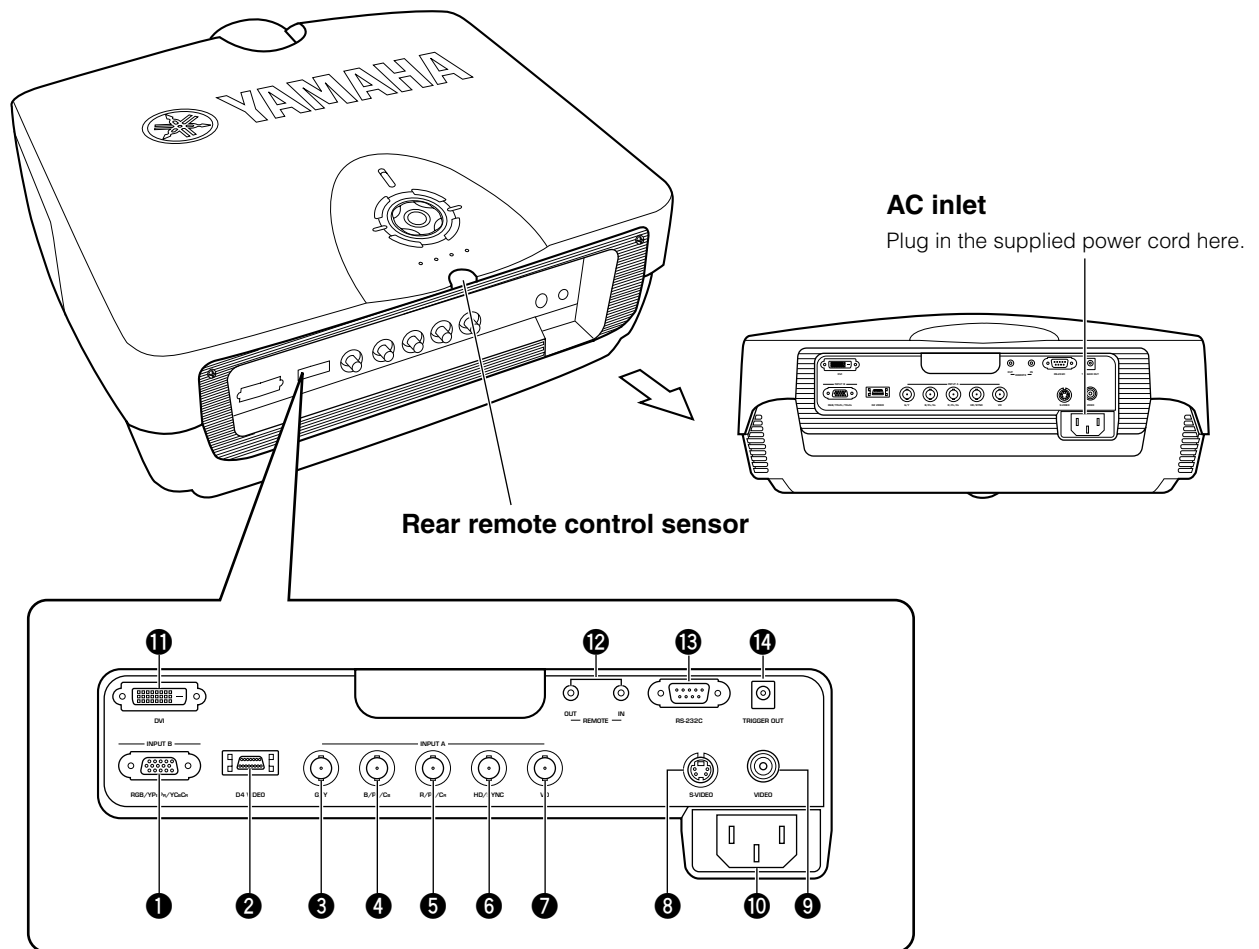

❶ INPUT B (D-Sub 15 pin)

This is the input connector for signals (RGB/YPbPr/YCbCr) from a component video or RGB source. Use a D-Sub monitor cable when connecting another component to the DPX-1000 through this connector.

❷ D4 VIDEO (D connector)

This connector receives video signals from the D connector of other A/V components. It is compatible with the D1—D4 formats. (This connector is designed for the Japanese D format only.)

❸—❷ INPUT A (BNC jacks)

These are input jacks for signals from component video or RGB sources. Component signals from A/V equipment should be connected to ports ❸—❷, and RGB signals from Computer equipment to ports ❸—❷. Use a BNC cable when connecting other components to the DPX-1000 through these jacks.

- ❸ G/Y (G, or luminance signal)
- ❹ B/Pb/Cb (B, or color difference signal)
- ❺ R/Pr/Cr (R, or color difference signal)
- ❻ HD/SYNC (horizontal sync signal, composite sync signal)
- ❼ VD (vertical sync signal)

❽ S-VIDEO (Mini DIN jack)

This jack receives S VIDEO signals from the S-VIDEO output jack of other A/V components. Use an S VIDEO cable when connecting other components to the DPX-1000 through this jack.

❾ VIDEO (Pin jack)

This jack receives composite signals from jacks of other A/V components. Use a video pin cable when connecting other components to the DPX-1000 through this jack.

❿ AC inlet

⓫ DVI (DVI jack)

This jack receives DVI signals from computer equipment or DVI signals from A/V equipments.

⓬ REMOTE IN/OUT jack

Connect the remote control to the IN jack when using it through a cable. Codes input through the IN jack will be output directly through the OUT jack.

⓭ RS-232C (D-sub 9 pin)

This jack is used for factory testing.

⓮ TRIGGER OUT

This jack outputs control signals to external components. A potential of 12V/Maximum 200 mA is provided when the DPX-1000 is projecting.

■ Remote control

Buttons with identical names to those on the main unit perform identical functions. To use the remote, point it at the remote control sensor on the front or back of the unit from a distance of no more than 7 m (23 feet).

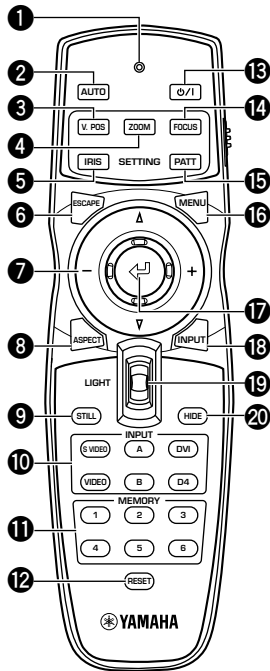

- 1 Transmit indicator**
This indicator will light up when the unit is sending infra-red signals to the main unit.
- 2 AUTO button**
Pressing this button will automatically adjust the unit to the best settings for projection by retuning the frequency of the projection to that of the source component.
- 3 V. POS button**
Switches on and off the adjustment mode for the vertical positioning of the entire image.
- 4 ZOOM button**
Switches on and off the size adjustment mode for the image being projected.
- 5 IRIS button**
Switches on and off the lens iris diaphragm change mode.
- 6 ESCAPE button**
Press this button to exit from a sub-menu.
- 7 Cursor buttons**
Use the Δ , ∇ , $-$, $+$ buttons to move the cursor within the interface.
- 8 ASPECT button**
Selects the display aspect of the projection image. Press the button to display the aspect presently being used. Pressing the button again within 2 seconds will switch the unit to the next aspect mode.
- 9 STILL button**
Stops a moving image to display a still of the desired image. Press **STILL** again to cancel this function.

- 10 INPUT area**
Directly selects the input jack.
- 11 MEMORY area**
Calls up stored video memory directly.
- 12 RESET button**
Press this button to reset all parameters altered in the menu to their default factory settings.
- 13 φ/I button**
Switches the unit between Standby and On (operational) modes.
- 14 FOCUS button**
Switches on and off the focus adjustment mode for the image being projected.
- 15 PATT (PATTERN) button**
Switches the built-in test pattern display on and off.
- 16 MENU button**
Press this button to display the general settings and adjustments menu.
- 17 (Enter) button**
Use this button to set values and enter into submenus when the menu is being displayed. Pressing the button when the menu is not being displayed will call up the in-line menu. (see page 28.)
- 18 INPUT button**
Press this button to display the input source and input signal selection menu.
- 19 LIGHT switch**
Pressing this switch will light up the often used **2**, **6**, **8**, **13**, **16**, **18** buttons. The lights will switch off if no operation is performed within 10 seconds.
- 20 HIDE button**
Press this button to temporarily halt projection of the image being displayed. Press the **HIDE** button once more to cancel this function.

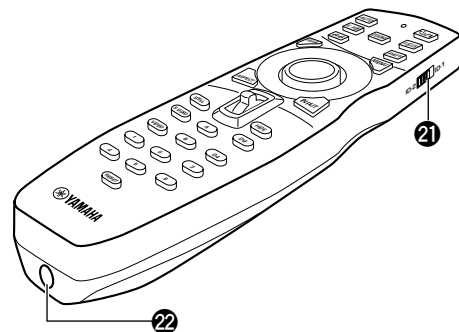

- 21 Remote control code switch**
This remote control will work when it has the same code as that set on the menu. The default setting on the menu is ID-1.
- 22 Remote control cable jack**
Use this jack to connect the remote control to the main unit with a cable.

■ Using the remote control

Use the remote control under the following conditions. The remote control will not function if it is used outside the angles and/or range detailed here.

Usable distance	Usable angle
7 m (23 feet)	30 degrees

A left/right arc of 30 degrees

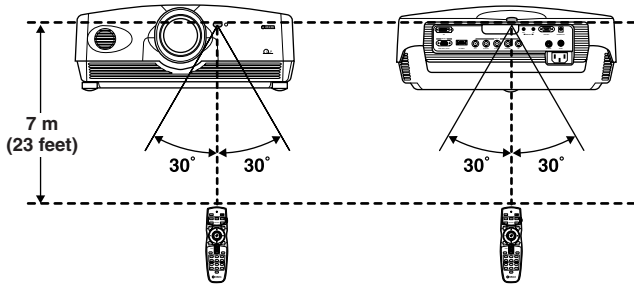

A vertical arc of 30 degrees

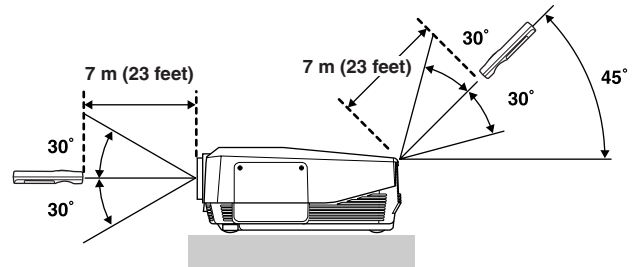

Important

- Bright light, fluorescent light etc. on the remote sensor on the main unit may inhibit the normal functioning of the remote control.
- The remote may not function normally if there is an obstacle blocking the signal between the remote and the remote control sensor on the main unit.
- The above are approximate figures.

■ Loading the batteries into the remote control

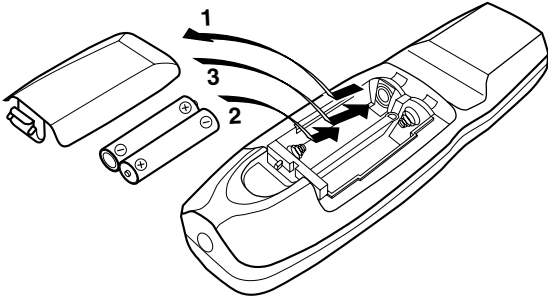

1. Remove the battery compartment cover from the back of the remote control.
2. Insert two batteries (AA, UM3, or R6 type), matching the polarity markings (+, -) on the batteries with those in the battery compartment.
3. After inserting the batteries, close the cover until it snaps into place.

Important

- If the remote must be used closer to the main unit than normal, or does not always operate correctly, exchange the batteries for new ones.
- Do not mix old and new, or different types of battery.
- Remove the batteries if you do not plan to use the unit for a long time.
- If the batteries leak, dispose of them immediately, taking care not to touch the battery fluid. If the battery fluid comes into contact with your eyes, mouth, or skin, rinse it off with water immediately and consult a doctor. Clean the battery compartment thoroughly before installing new batteries.

■ Using the remote as a wired remote control

To use the remote control as a wired remote control, use a 2P monaural miniplug to connect the remote control cable jack on the underside of the remote control to the REMOTE IN jack on the main unit.

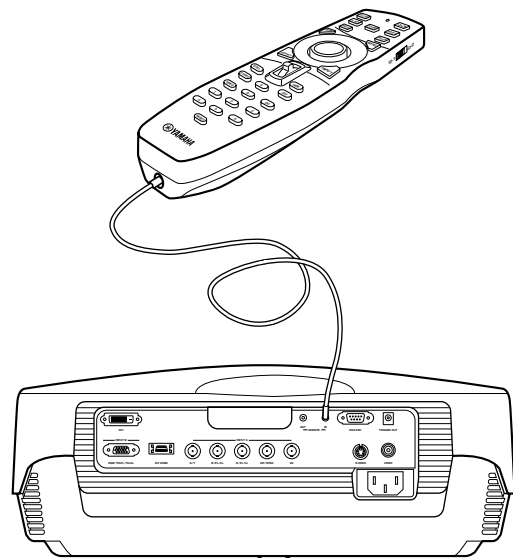

Installation

■ Installation methods

There are four ways to install this unit:

- on a table in front of the screen.
- mounted on the ceiling in front of the screen.
- on a table behind a semi translucent screen.
- mounted on the ceiling behind a semi translucent screen.

Set the method you use on the ④ <SETUP> section of the MENU described later. (see page 21.)

<Mounting on a table>

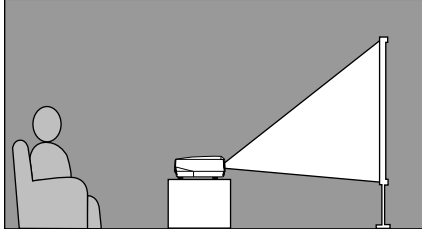

Place the unit on a standard height table to project and view the image from in front of the screen. The height from the bottom of the unit to the center of the lens is 12.4 cm (4⁷/₈).

<Mounting on the ceiling>

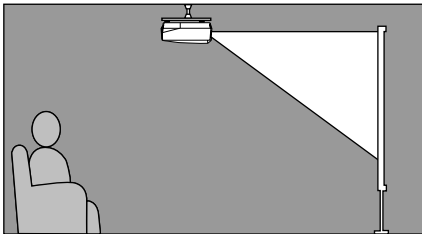

There are two kinds of brackets (low ceiling and high ceiling, sold separately) available which can be used to mount the unit on the ceiling. Consult your dealer for details on their use, and have installation done by either your dealer or a reputable contractor.

The image on the screen is vertically reversed compared to that of a table mounted installation. In this case, please set the installation type to FRONT/CEILING in the ④ <SETUP> section of the menu. (see page 21.)

<Mounting the unit on a table or on the ceiling from behind a semi translucent screen>

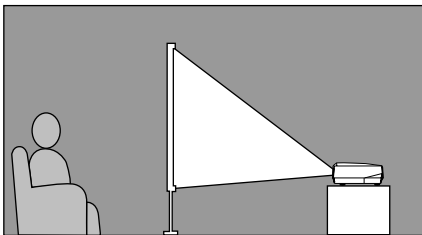

In this case, images are projected onto a semi translucent screen, and the viewer watches it from the reverse side. The relationship with the screen and projection distance corresponds to that for front projection. For rear projection, set the installation type to REAR/CEILING or REAR/TABLE in the ④ <SETUP> section of the menu. (see page 21.)

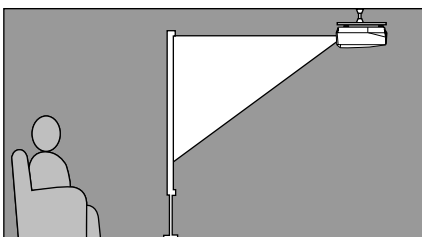

■ Screen and projection distance

The ideal position for mounting the main unit (Projection distance [a]) depends on the size of the screen to be used (the length of a diagonal line across the screen). It is possible to adjust the projection distance within a preset range from Wide to Tele using the zoom function. Additionally, it is possible to adjust the V. POS (Vertical positioning) of the image to better suit the screen. Use the information illustrated in the figure below to determine the best position for installation.

<When using a 16:9 screen>

Screen size	Projection distance [a]	
	Wide (m) — Tele (m)	(feet, inches)
60	1.8 — 2.88	5'11" — 9'5"
70	2.1 — 3.36	6'10" — 11'
80	2.4 — 3.84	7'10" — 12'7"
90	2.7 — 4.32	8'10" — 14'2"
100	3.0 — 4.8	9'10" — 15'9"
110	3.3 — 5.28	10'10" — 17'4"
120	3.6 — 5.76	11'10" — 18'11"
150	4.5 — 7.2	14'9" — 23'7"
200	6.0 — 9.6	19'8" — 31'6"

<When using a 4:3 screen>

Since the DPX-1000 is equipped with a 16:9 element, the ideal installation position for viewing images with a 4:3 screen depends on the size of the desired image projection.

- ① When a standard 16:9 image completely fills the width of the screen (leaving black line at the top and bottom of the screen)
- ② When the standard 4:3 image completely fills the screen

Screen size	Projection distance	
	① Wide — Tele (m), (feet, inches)	② Wide — Tele (m), (feet, inches)
60	1.65 m — 2.64 m 5'5" — 8'8"	2.2 m — 3.52 m 7'3" — 11'7"
80	2.2 m — 3.52 m 7'2" — 11'7"	2.9 m — 4.64 m 9'6" — 15'3"
100	2.75 m — 4.4 m 9' — 14'5"	3.65 m — 5.84 m 12' — 19'2"
120	3.3 m — 5.28 m 10'10" — 17'4"	4.4 m — 7.04 m 14'5" — 23'1"
200	5.5 m — 8.8 m 18' — 28'10"	7.3 m — 11.68 m 23'11" — 38'4"

- ③ Projecting both 16:9 and 4:3 images
It is possible to use the zoom function to make use of the screen efficiently for both ① and ② above. The projection distance in this case will be between Wide in ② and Tele in ①. Adjust the size of the projected image using the zoom so that all images fill the screen completely. However, please be aware that adjustments to V. POS can cause the position of the image to slip.

For a 16:9 screen

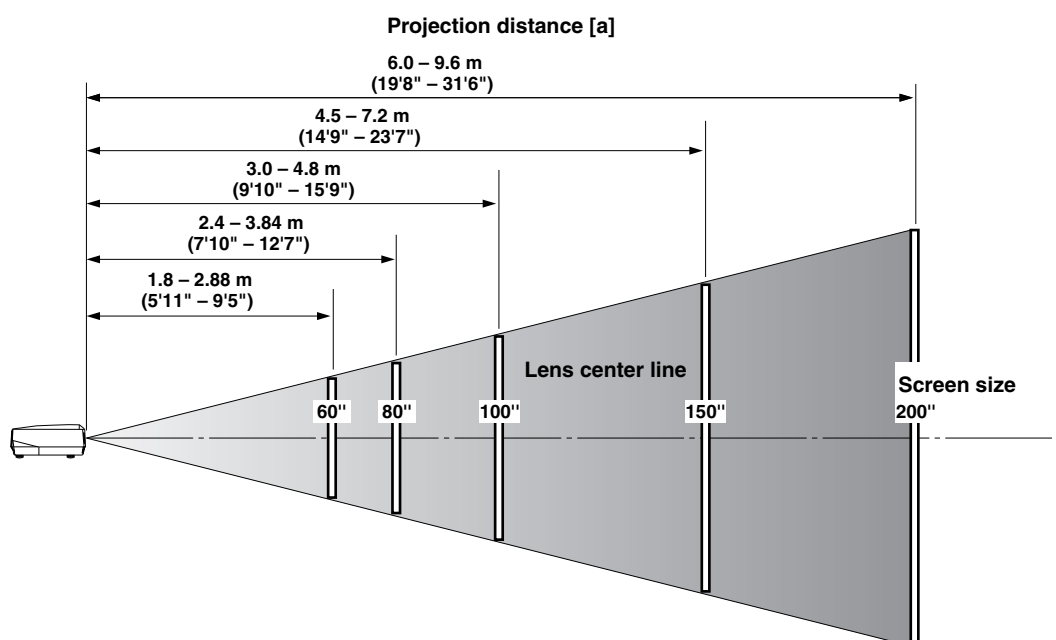

*These are theoretical numerical values.
Please be aware that there may be some discrepancy in comparison to actual values.

■ Projection image position

Follow the instructions below to adjust the position of the projected image on the screen.

<Adjusting using the zoom>

This figure shows the limits within which the zoom function can alter projection distance in relation to the screen size. Within these limits, it is possible to adjust the image so that it fills the screen completely. (See page 12.)

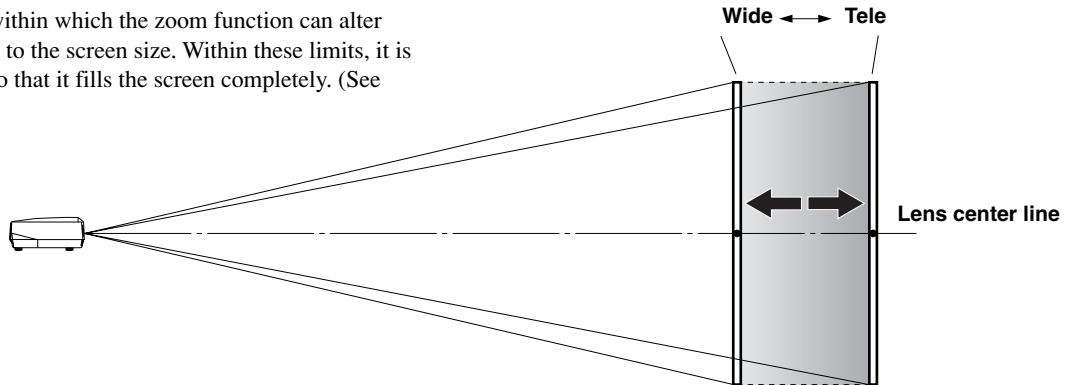

<Adjusting using the V. POS (vertical positioning)>

It is possible to adjust the vertical position of the projected image on the screen up or down by half the height of the screen. For example, shifting V. POS fully up will bring the lower limit of the image above the centerline of the lens. (See page 12.)

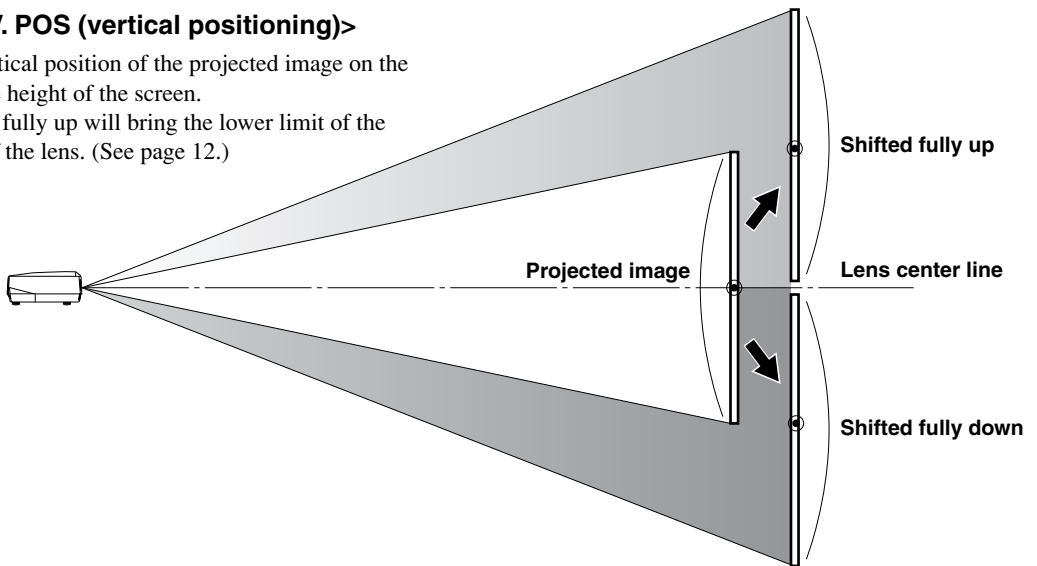

<Adjusting using the adjusters>

When this unit is mounted on a tabletop, the position of the image can be adjusted by using the adjusters located on the underside of the unit. Adjust the height by rotating the movable part of the two screw-type adjusters at the front bottom of the case. The adjustment range of these adjusters is 3 cm (1-1/4 inch). Adjust with care as loosening them further may cause them to separate from the main unit.

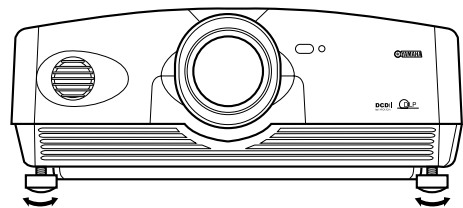

■ Keystone

When the unit is mounted at an angle to the screen, the image will be projected in a trapezoid manner. Use the keystone function in the keystone section of ④ <SETUP> in the menu to rectify this. (See page 21.)

Connecting the unit

- Make sure that the power of this unit and all other components is turned off before making any connections.
- Some components have different connection methods and connector names. Refer to the operating instructions for each component that you wish to connect.
- Plug the unit in correctly to prevent it from creating noise or other problems.

■ Connecting A/V components

As shown in the illustration below, there are 6 types of connections provided on this unit for connection to A/V components. Follow the instructions on the figure below to connect A/V video outputs from other components to this unit using the correct cables and adapters.

Input	Signal type	Connector type
VIDEO	Composite video	Pin jack
S-VIDEO	S video	Mini DIN connector
INPUT A	Component video/RGB video	BNC connector x 3—5
INPUT B	Component video/RGB video	D-sub 15 pin
D4 VIDEO	Component video	D connector
DVI	Component video/RGB video (digital)	DVI connector

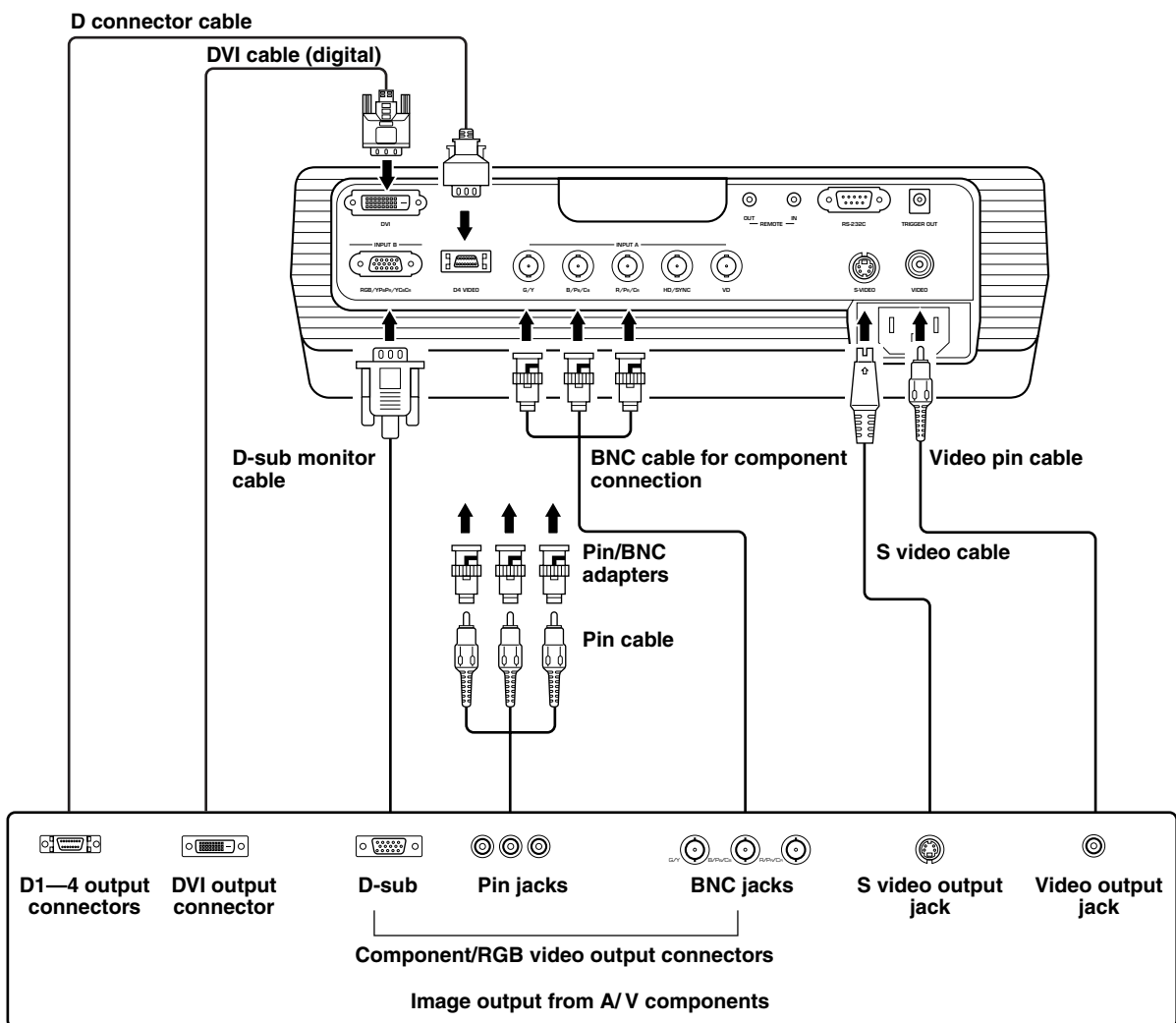

◆ Note ◆

- Make sure to match the Y/PB/PR or Y/CB/CR of the A/V component and this unit when connecting a component to INPUT A component jacks. Also, refer to the operation instructions for the A/V component. HD/SYNC and VD need to be connected for RGB video signals in some cases.

■ Connecting to a computer

There are three ways of connecting a computer, as listed below. Please use the correct type of cable for the connector when making connections.

Input	Signal type	Connector type
INPUT A	RGB Analog	BNC jack x 5
INPUT B	RGB Analog	D-sub 15 pin
DVI	RGB Digital	DVI connector

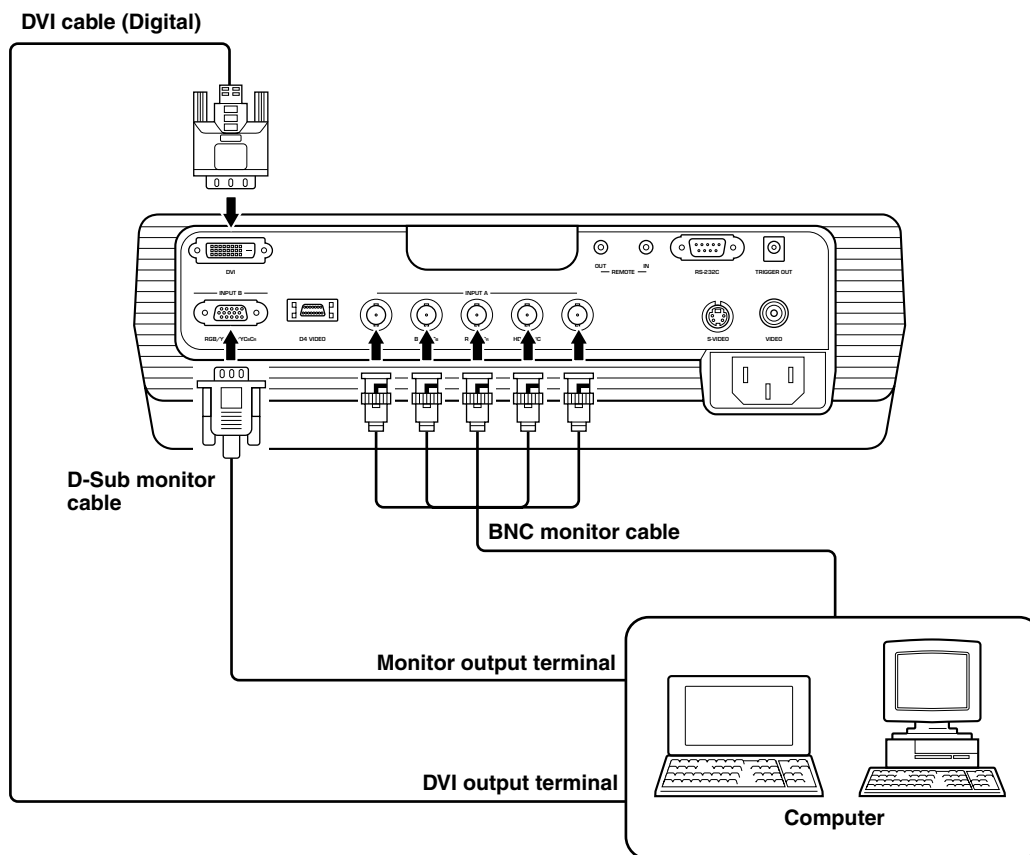

◆ Note ◆

- Refer to see ② <SIGNAL> in the menu described on page 19 for detailed settings for the type of image signal input.

Basic Operations

This section describes the basic operation of the DPX-1000 once installation and connection have been completed. It is necessary to make detailed settings in the menu described later so that the DPX-1000 is correctly set for the mounting, screen, input signals, and other conditions of its installation. Follow the steps described in this section to carry out these procedures.

■ Turning on the power

Be sure to remove the lens cover before using this unit.

1. Plug the supplied power cord into the AC inlet on the rear of the DPX-1000, then plug the cord into the wall outlet. The STANDBY/ON indicator will turn orange.

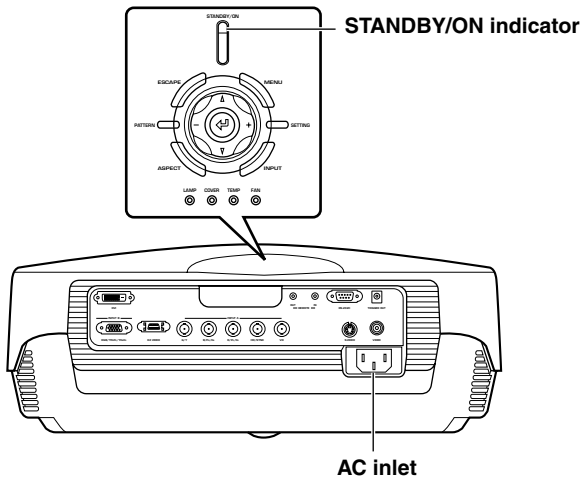

2. Press the STANDBY/ON button (The \downarrow/\uparrow button on the remote control). The indicator will blink green and the lamp inside the unit will light up, in preparation for projection.

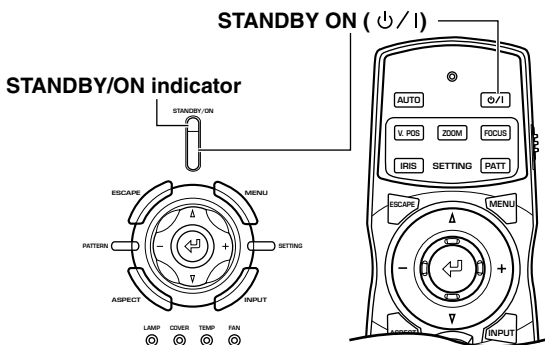

◆ Note ◆

- There are STANDBY/ON indicators located on the front panel and the control panel of the main unit.
3. After approximately 35 seconds, the indicator will stop blinking, indicating that preparations for projection are complete.

Important

- Be sure not to disconnect the power cord while the power STANDBY/ON indicator is green, or blinking green. This can cause significant damage to the lamp and may result in a shorter lamp life or failure.

■ Turning off the power

1. Press the STANDBY/ON button when finished using this unit.

There will be a message to confirm that you wish to turn the unit off. Press the **STANDBY/ON** button once more to confirm that you wish to do so. The lamp will switch to a half-lit state, and the fan continues for roughly 2 minutes to cool the lamp. During this time, the STANDBY/ON indicator blinks orange. You cannot turn the unit on again by pressing the **STANDBY/ON** button during this time.

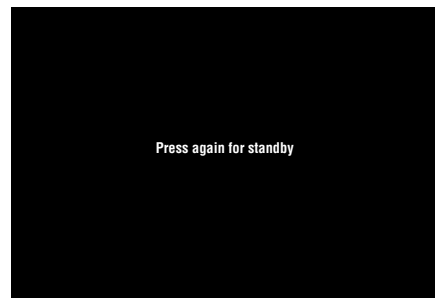

◆ Note ◆

- The lamp may blink when in the half-lit state. This is not a lamp failure.
2. Once cooling is completed, the STANDBY/ON indicator will cease blinking, becoming a steady orange.

Important

- Do not disconnect the power cord when the fan is going and the STANDBY/ON indicator is blinking orange. This could damage the lamp and result in shorter lamp life or lamp failure.

3. Replace the lens cover and disconnect the unit from the power outlet if you do not plan to use it for a long time.

Important

- Condensation may appear on the unit if the temperature of the surround environment changes quickly. Condensation may also cause the projected image to be cloudy. Switch off the unit power until the condensation disappears. Switching the unit on when condensation is present may damage the unit.

■ Preparations for projection

Carry out the adjustments necessary to the projection image to obtain the optimum setting for projection.

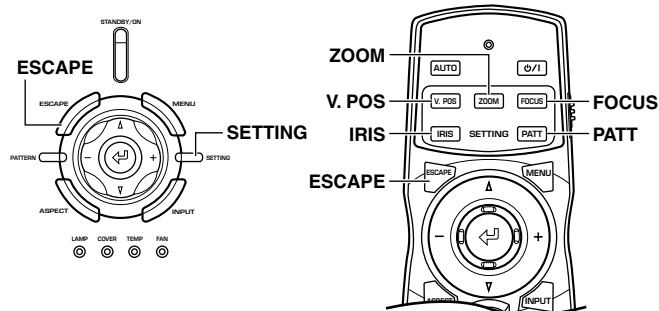

<Adjusting the vertical position with V. POS>

The initial setting on this unit is for projection of the image in a line directly from the center of the lens. Where the center of the screen is above or below the center of this line, use the V. POS function to adjust the vertical position of the image up or down. V. POS can adjust the image up to half the height of the screen.

1. Press the V. POS button on the remote control or the SETTING button on the main unit repeatedly to place the unit in vertical position adjustment (Lens shift) mode.
2. Adjust the image to a suitable position by pressing either the Δ or ∇ buttons.
3. Press the V. POS button again or the ESCAPE button to exit from the vertical position adjustment mode.

<Adjusting image size with ZOOM>

Enlarge or reduce the size of the image to fit the size of the screen. The maximum extent of this zoom is 1:1.6.

1. Press the ZOOM button on the remote control or the SETTING button on the main unit repeatedly to place the unit in zoom adjustment (Zoom) mode.
2. Adjust the image to a suitable size by pressing either the Δ or ∇ buttons.
3. Press the ZOOM button again or the ESCAPE button to exit from the adjustment mode.

<Adjusting focus with FOCUS>

Adjust the focus of the projected image.

1. Press the PATT button on the remote control or the PATTERN button on the main unit to display a test pattern for adjustment.
2. Press the FOCUS button on the remote control or the SETTING button on the main unit repeatedly to place the unit in focus adjustment mode.
3. Adjust the unit to an optimal focus setting by pressing either the Δ or ∇ buttons.
4. Press the FOCUS button again or the ESCAPE button to exit from the focus adjustment (Focus) mode.

<Adjusting the iris diaphragm with IRIS>

This unit is equipped with an IRIS function to switch between the high levels of black and high contrast images important in a home theatre and the bright images needed for a large screen. Use this function as best suits your needs.

1. Press the IRIS button on the remote control or the SETTING button on the main unit repeatedly to place the unit in iris diaphragm adjustment (Iris) mode.
2. Adjust the unit to an optimal iris setting by pressing either the + or - buttons.
3. Press the IRIS button again or the ESCAPE button to exit from the iris adjustment mode.

<Using the test pattern to perform adjustments>

This unit is equipped with three test patterns: a crosshatch pattern useful for focus adjustment, and gray scale and color bar patterns for image adjustment. Use them as best suits your needs.

1. Press the PATT button on the remote control or the PATTERN button on the main unit to display a test pattern for adjustment.
2. Select a suitable test pattern by pressing either the + or - buttons.
3. Press the PATT button again or the PATTERN button on the main unit to exit from the adjustment mode.

■ Select an input

Press the **INPUT** button to display the input selection menu on the screen. Use the Δ and ∇ to select a name from those on display and then press the \hookrightarrow to confirm your choice.

The signal settings for INPUT A, INPUT B and DVI will not change. To change them, press the **+** button to open the submenu, use the cursor buttons to select a suitable source from Component/RGB PC/RGB TV, and confirm the selection by pressing the \hookrightarrow button. You can select the terminal name directly from the input area on the remote control.

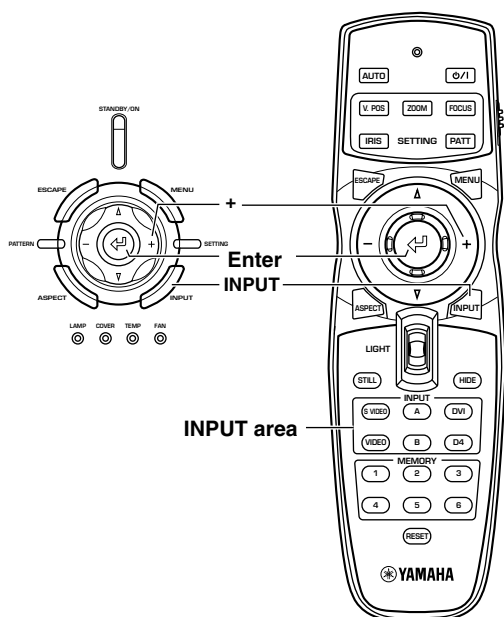

Input signal	
VIDEO	
S VIDEO	
INPUT A	Component
INPUT B	RGB PC
DVI	RGB TV
D4	

Input source	The image signal to project
VIDEO	Composite video signals input from an A/V component to the VIDEO jack
S-VIDEO	S video signals input from an A/V component to the S VIDEO jack
INPUT A <COMPONENT>	Component signals input to INPUT A (BNC jack)
<RGB PC>	RGB signals input from a computer to INPUT A (BNC jack)
<RGB TV>	RGB signals input from an A/V component to INPUT A (BNC jack)
INPUT B <COMPONENT>	Component signals input to the D-sub 15-pin connector on INPUT B
<RGB PC>	RGB signals input from a computer to the D-sub 15-pin connector on INPUT B
<RGB TV>	RGB signals input from a component to the D-sub 15-pin connector on INPUT B
DVI	<COMPONENT> Digital component signals input from an A/V component to the DVI connector
	<RGB PC> Digital RGB signals input from a computer to the DVI connector
	<RGB TV> Digital RGB signals input from an A/V component to the DVI connector
D4 VIDEO	Component signals input from an A/V component to the D4 video connector

◆ Note ◆

- Setting a laptop or notebook PC to display simultaneously on its built in display and on an external monitor can cause the image to be incorrectly displayed on the external monitor. In this case, set the PC to display on the external monitor only. Refer to the computer's operating instructions for further details.

■ Select a display aspect

Display aspect selects the type of image to display for an input signal. Press the **ASPECT** button and select a suitable mode. The types of aspect mode available depend on the input signal. Additionally, this unit has an auto mode that can automatically select the correct display aspect if the relevant information is encoded in the input signal. These modes are accessible from the display aspect area of the ② <SIGNAL> section of the menu described later.

① Auto (Zoom)

In this mode, when the input signal is letterbox or squeeze type, and such information is encoded in the input signal, the unit will detect this and automatically change to the most appropriate display aspect.

② Normal

In this mode, the aspect from the input signal is kept as is, and the image is projected vertically with an aspect of 16:9, filling the screen and leaving a black area to the left and right of the image.

③ Squeeze

This mode displays images that have been compressed horizontally in a normal wide aspect manner.

④ Smart Zoom

This mode stretches the left and right edges of a 4:3 image without altering the center, to project a 16:9 image which fills the screen.

⑤ Zoom

This mode projects images received in a letterbox format in a 16:9 format that completely fills the screen.

⑥ Subtitle Zoom

This mode is the most appropriate for showing subtitled letter box format video software. There are more detailed settings for this mode, which can be adjusted in the Subtitle Zoom area of the ② <SIGNAL> section of the menu. Refer to page 24 for details.

- Subtitle Area
Adjust the settings for subtitles.

- V Scroll
Adjust the position of the subtitles by moving the screen vertically.

⑦ Through

This mode displays the signal as it is input with no enlargement or reduction. The projected image size will vary according to the resolution of the signal.

⑧ Through Squeeze

This mode expands the width of the input signal to display the image in a 16:9 aspect. The projected image size will vary according to the resolution of the signal.

[Representative examples]

Input signal type	Input image	Display aspect	Projected image
Standard 4:3 image		Normal →	
		Smart Zoom →	
Letter box		Zoom →	
		Subtitle Zoom →	
Squeeze (Vista size)		Squeeze →	
		Through Squeeze →	
Squeeze (Cinemascope size)		Squeeze →	
HDTV		Normal →	
RGB PC		Normal →	

Other functions

STILL — freezing the image

Press the **STILL** button on the remote control to capture a frame from a moving image. Press **STILL** once more to resume normal projection.



HIDE — turning off the image temporarily

Press the **HIDE** button on the remote control to temporarily turn off the projected image. Press the **HIDE** button once more to resume normal projection.



Indicators

There are 5 indicators on the main unit that display the operating status of the DPX-1000.

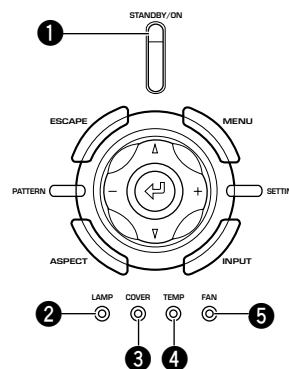

1 STANDBY/ON (There is also an LED on the front panel of the main unit.)

Off	The power is turned off.
Steady orange	Standby mode
Blinking green	Startup mode
Steady green	Operating
Blinking orange	Lamp cooling prior to going into Standby mode
Blinking red or red and orange	One of the LAMP/COVER/TEMP/FAN lights is also red. Consult a YAMAHA dealer or service center if this occurs.

2 LAMP	
Off	Normal
Blinking orange	Lamp usage has exceeded 2000 hours.
Steady red	The lamp has burnt out.

3 COVER	
Off	Normal
Steady red	Either the lamp cover or the filter cover is not correctly attached.

4 TEMP	
Off	Normal
Steady red	Either the internal temperature of the unit or the temperature of the lamp is abnormally high.

5 FAN	
Off	Normal
Steady red	The cooling fan is not working properly.

Menu structure

It is necessary to set various properties on a variety of menus so that this unit can project in optimal condition. There are four menu groups, each with a number of different menu items. Some of these items are not selectable for certain types of input signal, some have submenus attached, and others have a three stage menu hierarchy. (Displayed with a **S** overleaf.)

Each menu group consists of the items below. Follow the procedures outlined to adjust the parameters in each menu to suit your viewing requirements.

① **<IMAGE>**

These menu items make adjustments to the projection image. The menu details will vary depending on the input signal type.

- Black Level (Brightness)
- White Level (Contrast)
- Gamma Trim
- Hue
- Saturation
- Color Temp.
- Sharpness Type
- Sharpness Gain
- Color Balance
- Level Adjustment
- Iris

② **<SIGNAL>**

These menu items set parameters for the various input signals. The menu details will vary depending on the input signal type.

- Display Aspect
- 3D Y/C Separation
- Noise Reduction
- Video Type
- Progressive Mode
- Color Space Conversion
- Setup Level (SDTV)
- Setup Level (HDTV)
- Signal Level
- Sync Adjustment
- Tracking
- Horiz. Display Position
- Vert. Display Position
- Signal Status

③ **<INITIAL>**

These menu items set the initial parameters for a number of menu items.

- Color System
- INPUT A Signal
- INPUT A Sync Type
- INPUT B Signal
- INPUT B Sync Type
- DVI Signal
- Auto Power Off
- Auto Input Search
- Display Language
- Lamp Running Time
- Reset

④ **<SETUP>**

These menu items set parameters related to installation method, remote control and so on.

- Location
- Keystone
- Remote Control Sensor
- Remote Control ID
- Lens Adjustment Lock
- White Boost
- Economy Mode
- Menu Color
- Message
- Trigger Out
- Baud Rate

Menu Start Screen

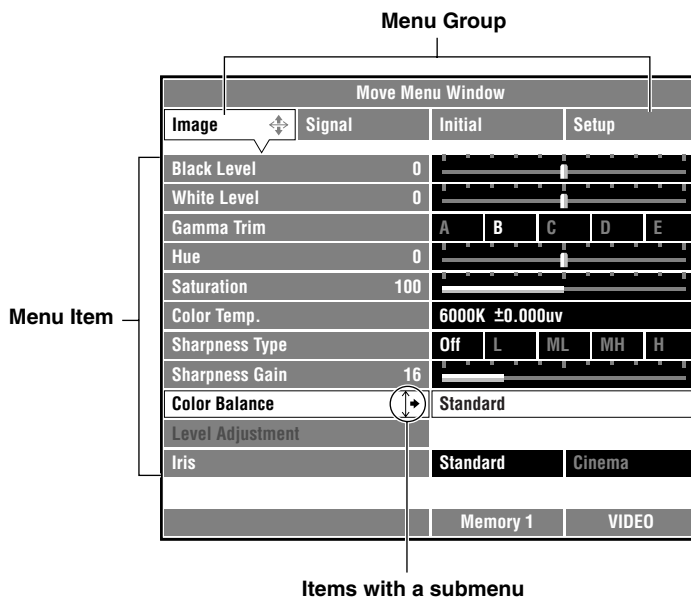



■ ① <IMAGE> You cannot adjust these settings without an input signal.

Input signal	Menu Item	Adjustment range
Video/Component, RGB TV	BLACK LEVEL Adjusts the level of blackness in an image while maintaining peak white brightness. Increasing the black level will increase the luminosity of dark scenes and clarify picture tone, however it will also lower the contrast. Reducing the black level will increase the contrast in dark scenes but will reduce the clarity of black tones.	-100 to 0 to +100
Video/Component, RGB TV, *RGB PC	WHITE LEVEL (*CONTRAST) Increases the level of whiteness in an image without changing the luminosity of the darker parts of the image. Increasing the white level will brighten the white areas of an image and increase contrast, however it will also reduce the clarity of white within the image. Reducing the white level will lower contrast.	-100 to 0 to +100 (*0.50 to 1.00 to 1.50)
*RGB PC	(*BRIGHTNESS) Controls the total brightness of an image. When set too high, the black portion of the image becomes grayish and the white portion of the image tends to be saturated. When set too low, the entire image becomes darker.	-100 to 0 to +100
	<div style="display: flex; justify-content: space-around;"> <div style="text-align: center;"> <p>BLACK LEVEL</p> </div> <div style="text-align: center;"> <p>WHITE LEVEL (*CONTRAST)</p> </div> <div style="text-align: center;"> <p>(*BRIGHTNESS)</p> </div> </div>	
Video/Component, RGB TV, RGB PC	GAMMA TRIM Adjusts the response of the color gradation and gray scale within the image. There are ten patterns available, on two pages of five patterns each. Use the $\leftarrow \rightarrow$ key to switch between the pages, and select the appropriate pattern for the contents to be viewed.	A/B/C/D/E a/b/c/d/e
Video/Component, RGB TV	HUE Adjusts the hue of the image. Reducing this setting increases the amount of red in the image. Increasing it will add blue to the image.	-100 to 0 to +100
Video/Component, RGB TV	SATURATION Adjusts color depth. Reducing the value of this setting lightens the color of the image, while increasing it will increase the depth of color.	0 to 100 to 200
Video/Component, RGB TV, RGB PC	COLOR TEMP. S Adjusts the level of white in colors between red and blue, and between green and magenta. A lower setting adds more red to the colors giving a more relaxed feel to the image, while a higher setting adds more blue, resulting in "fresh" color tones. Also, increase the ΔUV to give more green to the image, or reduce it to add more magenta.	5000K to 6000K to 10000K (COLOR TEMP.) -0.020UV to ± 0.000 to +0.020UV (ΔUV)

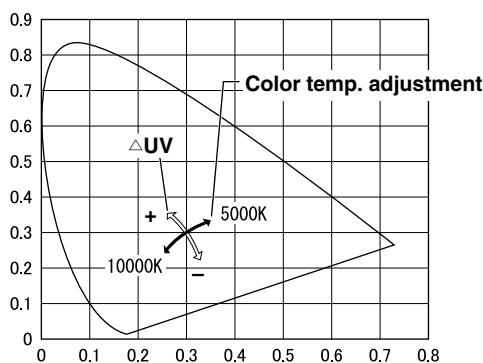
COLOR TEMP. ADJUSTMENT



Menu structure

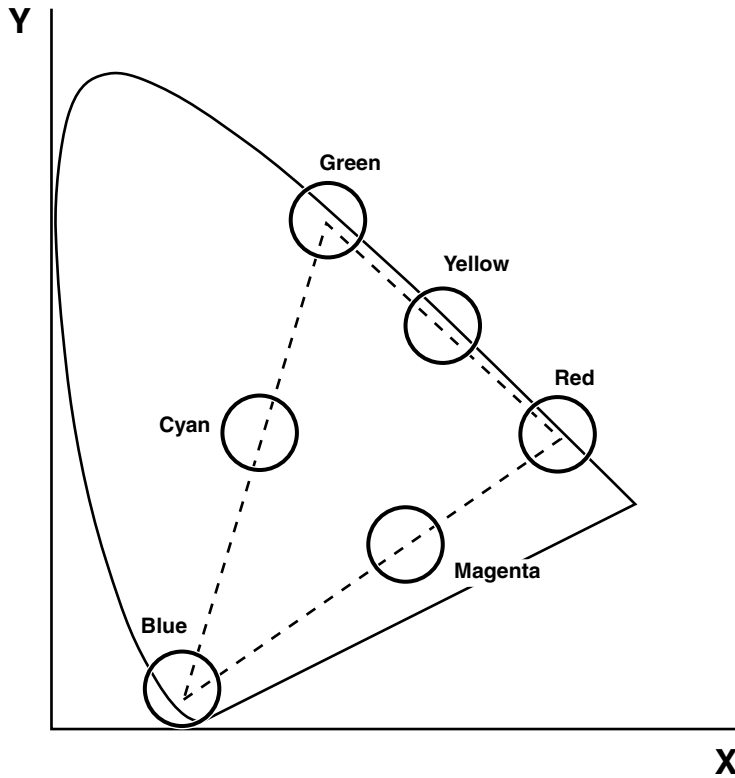

Input signal	Menu Item	Adjustment range
Video/Component, RGB TV	SHARPNESS TYPE Use this parameter to change the filtering characteristics of the circuitry used to sharpen edges in the projected image.	OFF/L/ML/MH/H
Video/Component, RGB TV	SHARPNESS GAIN Adjusts the clearness of the image edges. The higher value creates clearer edges. The lower value creates a softer image with less noise element.	0 to 16 to 63
Video/Component, RGB TV, RGB PC	COLOR BALANCE  The default setting displays a good balance of colors, which you cannot change. For RGB, this parameter adjusts the color balance and gain for the three primary colors R (red), G (green), and B (Blue). The intermediate colors Y (yellow), C (cyan), and M (magenta) are set automatically based on the RGB and color temperature settings. From the RGB submenu, press the RESET key on the remote control to automatically adjust the RGB setting and based on the color gain and temperature you have just set. For RGBYCM, you should set the color balance and gain for each color separately. From the RGBYCM submenu, press the RESET key on the remote control to automatically adjust the RGB or YCM tone and based on the color gain and temperature you have just set. Refer to the color chart below for further help in adjusting parameters. You can change the background color to black by pressing the  key when setting the COLOR COORDINATE.	STANDARD/RGB/RGBYCM

XYZ color system color chart









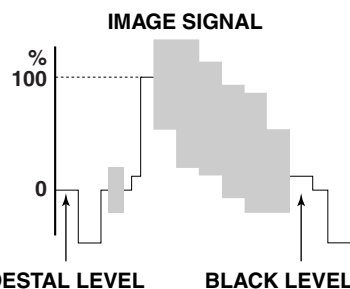

Component, RGB TV, RGB PC	LEVEL ADJUSTMENT  Adjusts gain and offset for all parameters (Y, C _B , C _R /R, G, B) of component and RGB signals. (except DVI input)	-50 to 0 to +50
Video/Component, RGB TV, RGB PC	IRIS IRIS set this parameter to STANDARD for viewing bright images on a large screen. Set it to CINEMA if you want to give priority to the deep blacks and high contrast important to home theatre viewing.	STANDARD/CINEMA

■ ② <SIGNAL> You cannot adjust the parameters below if the unit is not receiving an input signal.









Input signal	Menu Item	Selections
Video/Component, RGB TV, RGB PC	DISPLAY ASPECT  Sets the aspect ratio to use when projecting an image for a given input signal. Under AUTO mode, the unit will automatically switch to the most suitable mode for display. NORMAL (THROUGH) mode projects the image as is without an alteration to the signal. SQUEEZE displays horizontally compressed images in a normal non-compressed manner. ZOOM projects the image scaled up by a given ratio. SMART ZOOM expands a 4:3 image to 16:9 size. SUBTITLE ZOOM displays subtitles. THROUGH SQUEEZE displays an image with the width scaled up. The availability of these options depends on the type of input signal. Depending on the state of the input source, it may not be possible for the unit to automatically select the optimal display mode. In this case, please select an appropriate mode manually. SUBTITLE ZOOM contains the following parameter settings: SUBTITLE AREA: Adjusts the subtitle display area V SCROLL: Adjusts the vertical position of subtitles	AUTO/NORMAL/ SQUEEZE/SMART ZOOM/ZOOM/ SUBTITLE ZOOM  (SUBTITLE AREA, V SCROLL)/THROUGH/ THROUGH SQUEEZE
Video(NTSC)	3D/Y/C SEPARATION Suppresses the rainbow like color crossing and annoying dots in the image received from video input. This choice is only available for NTSC format signals from composite inputs.	0 to 3 to 10 -10 to 4 to +10 OFF/ON
Video/Component, RGB TV	NOISE REDUCTION Uses digital processing to eliminate noise in the luminance and color signals in sources with a comparatively large amount of noise, producing a more vivid image. Use where warranted by source quality.	OFF/1/2/3
Video	VIDEO TYPE To ensure synchronization, select VCR when using analog videotape as a video input source. Select DVD for other sources.	DVD/VCR
Video/Component, RGB TV	PROGRESSIVE MODE Switches the mode of interlace/progressive (I/P) conversion for the built in Faroudja function. AUTO distinguishes film source automatically and projects it progressively at 60 frames per second. Video turns the distinction function off. Both of these modes use the DCDi function. (Only for SDTV interlaced signals)	AUTO/VIDEO
Video/Component	COLOR SPACE CONVERSION Selects color space coefficients for SDTV BT.601 and HDTV BT.709 type signals. In the AUTO mode, the unit will automatically select an appropriate mode based on the resolution of the signal.	AUTO/SDTV/HDTV
Video/Component, RGB TV	SETUP LEVEL (SDTV) Compensates for the differences in blackness levels in normal image signals. It sets the level for signals equal to the pedestal level at 0%, and those for signals with high levels of blackness at 7.5%.	0%/7.5%
Component, RGB TV	SETUP LEVEL (HDTV) Compensates for the differences in blackness levels in HDTV signals. It sets the level for signals equal to the pedestal level at 0%, and those for signals with high levels of blackness at 7.5%.	0%/7.5%
RGB TV	SIGNAL LEVEL The function to change the range of the digital signal level of the input image. Use 16—235 for a standard STB (Set Top Box) connection, or use 0—255 for a PC compatible connection. (Only for DVI Signals)	16—235/0—255
RGB PC	SYNC ADJUSTMENT Regulates flickering, noise, and disorder in the projection image. (except DVI input)	-128 to 0 to +127
RGB PC	TRACKING Regulates vertical striping in the image. (except DVI input)	0 to 16 to 31
RGB PC	HORIZ. DISPLAY POSITION Adjusts the horizontal positioning of the projection image. (except DVI input)	-50 to 0 to +50
RGB PC	VERT. DISPLAY POSITION Adjusts the vertical position of the projection image. (except DVI input)	-50 to 0 to +50
Video/Component, RGB TV, RGB PC	SIGNAL STATUS  Displays the resolution of the input signal, and synchronization information for RGB signals.	

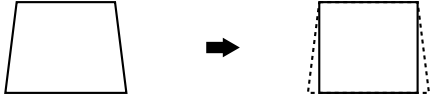

■ ③ <INITIAL>

Menu item	Selections
<p>COLOR SYSTEM </p> <p>Selects the color system to use when the input signal is from a video source. Available selections are NTSC, NTSC4.43, PAL, PAL-M, PAL-N, PAL60, and SECAM. Usually, setting the unit to AUTO will result in the unit automatically selecting the appropriate color method. However, since the unit does not automatically detect NTSC4.43 under AUTO mode, set the color method to NTSC4.43 manually to view NTSC4.43 images.</p>	AUTO/NTSC/NTSC4.43/PAL/PAL-M/PAL-N/PAL60/SECAM
<p>INPUT A SIGNAL </p> <p>Selects the type of input signal received at INPUT A.</p>	COMPONENT/RGB PC/RGB TV
<p>INPUT A SYNC TYPE </p> <p>Selects the sync mode of the input signal received from INPUT A. (For RGB TV only)</p>	AUTO/Separate Sync/Composite Sync/Sync on Green
<p>INPUT B SIGNAL </p> <p>Selects the type of input signal received at INPUT B.</p>	COMPONENT/RGB PC/RGB TV
<p>INPUT B SYNC TYPE </p> <p>Selects the sync mode of the input signal received from INPUT B. (For RGB TV only)</p>	AUTO/Separate Sync/Composite Sync/Sync on Green
<p>DVI SIGNAL </p> <p>Selects the type of input signal received at DVI.</p>	COMPONENT/RGB PC/RGB TV
<p>AUTO POWER OFF</p> <p>Setting the power saving mode to ON will cause the unit to automatically turn off the lamp and place itself in the standby mode if no signal is received through the inputs on the main unit for 30 minutes.</p>	OFF/ON
<p>AUTO INPUT SEARCH</p> <p>This function changes the input signal as shown below when the unit is not receiving a signal at the selected input, or is not receiving a signal at the input selected prior to turning the unit on.</p> <p>↳ INPUT A → INPUT B → D4 VIDEO → S VIDEO → VIDEO → DVI</p>	OFF/ON
<p>DISPLAY LANGUAGE </p> <p>Selects the language to use in the menu display.</p>	日本語/English/Deutsch/Español/Français/Italiano/Portuguêsa/한국어/中文
<p>LAMP RUNNING TIME </p> <p>Displays the total lamp running time. You can reset the lamp running time in the submenu attached to this menu item.</p>	
<p>RESET </p> <p>Resets all parameters on the menu and held in memory to their default factory settings.</p>	ALL SETTINGS/ALL MEMORIES/CURRENT MEMORY

■ ④ <SETUP>

Menu item	Selections
LOCATION  There are four ways of installing this unit; tabletop or ceiling mounting for front or rear projection. The DPX-1000 will invert or rotate the projection according to this setting.	FRONT/TABLE, FRONT/CEILING, REAR/TABLE, REAR/CEILING
KEYSTONE If the projection unit is at a horizontal or perpendicular angle to the screen the projection image will be distorted to a trapezoid shape. Use the KEYSTONE setting to electronically correct without increasing the length of the image. Increase the value when the top of the image is overly wide, and reduce the value when the lower part of the image is too wide.	-100 to 0 to +100
<p>When the upper part of the image is wider than the lower</p>  <p>Increase the value in the positive (+) direction</p>	
<p>When the lower part of the image is wider than the top</p>  <p>Decrease the value in a negative (-) direction</p>	
REMOTE CONTROL SENSOR  Use this parameter for switching between the 2 sensors located on the front and rear of the main unit that receive signals from the remote control. You can operate the main unit with a wired remote regardless of how this parameter is set.	FRONT&REAR/FRONT/REAR/OFF
REMOTE CONTROL ID  The main unit can receive commands from the remote control if you set the same ID in the main unit as is set by the code change switch on the side of the remote control. Use this code change switch to allow one remote to control two main units independently.	ID 1/ID 2
LENS ADJUSTMENT LOCK Locks the lens so that the V. POS, ZOOM, and FOCUS settings cannot be changed accidentally. Set to OFF to cancel this function.	OFF/ON
WHITE BOOST Enhances the luster of the white part in the projected image.	OFF/ON
ECONOMY MODE Lowers power supply to the lamp by approximately 20% to prolong its life.	OFF/ON
MENU COLOR  Selects the color of the characters and background for the on-screen menu display. Press the + or button to access the submenu and change color selections.	MONOTONE/COLOR
MESSAGE Set whether to display messages of any type on screen.	OFF/ON
TRIGGER OUT  Set the external control TRIGGER OUT terminal 12V signal emission to "LAMP" to synchronize it to the ON/OFF state of the lamp, to "FAN" to synchronize it to the fan, and to "RS-232C", to receive ON/OFF signals through the RS-232C terminal.	LAMP/FAN/RS-232C
BAUD RATE  Sets the transmission speed of the RS-232C terminal. This setting becomes valid from the next time you switch the unit on.	9600bps/19200bps/38400bps/57600bps/115200bps

Menu operation

Menu screen and operating buttons

This section provides you with general information about the menu screen and operating buttons on the remote control and this unit's control panel for easier operation. Please read it carefully before starting to operate the menu.

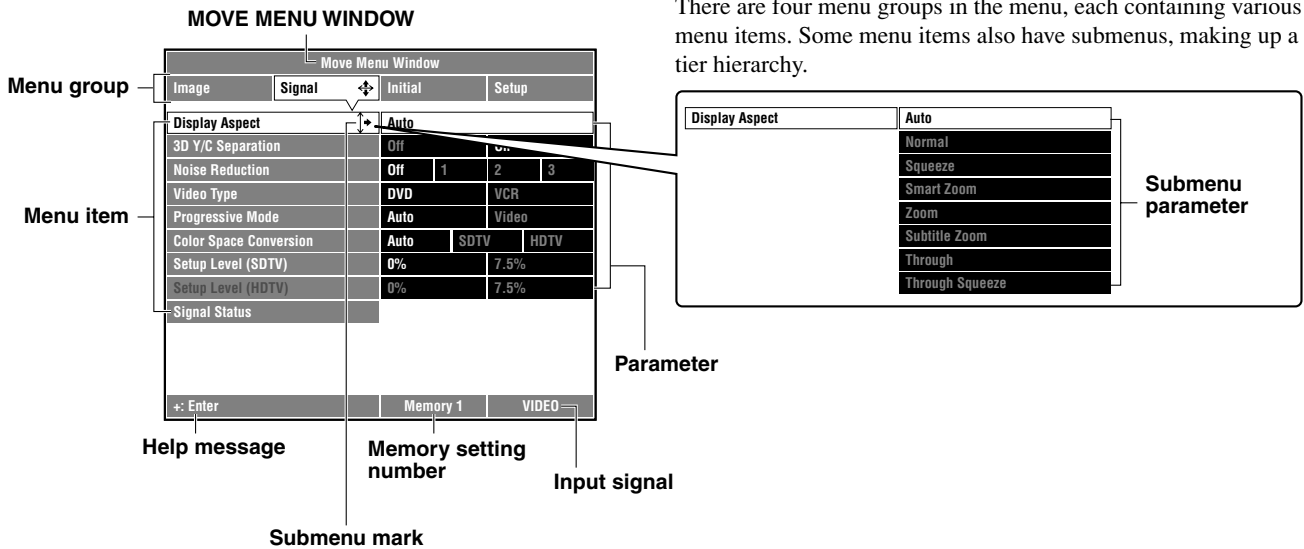

There are four menu groups in the menu, each containing various menu items. Some menu items also have submenus, making up a 3 tier hierarchy.

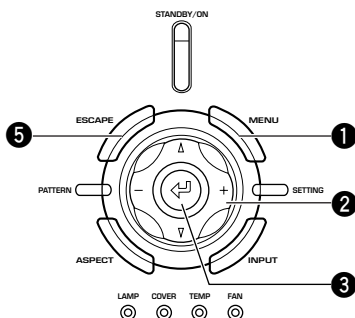
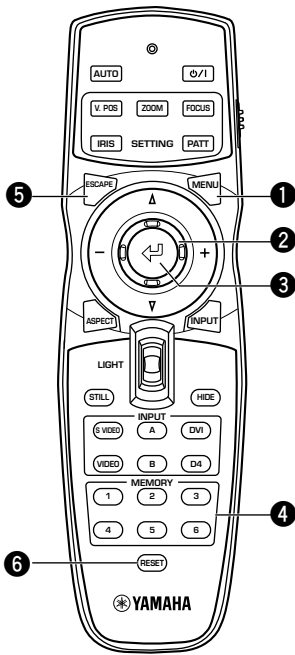

1 MENU button

Opens or closes the menu.

2 Cursor buttons

+/- (for side-to-side movements)

- Select a menu group.
- Open and close submenus.
- Select or change settings.

△/▽ (for up and down movements)

- Select a menu item.
- Select or change settings.

3 ↵ button

- Opens a submenu.
- Confirm a new setting when adjusting “COLOR SYSTEM”, “INPUT A SIGNAL”, “INPUT B SIGNAL”, “DVI SIGNAL”, “LOCATION”, “REMOTE CONTROL SENSOR”, or “REMOTE CONTROL ID”.
- Opens a one-touch image menu when the menu screen has not been opened.

4 MEMORY buttons 1—6 (Remote control only)

Select a memory setting number.

5 ESCAPE button

- Returns the cursor to the menu group hierarchy from the menu item hierarchy.
- Closes the submenu.
- Closes the menu when the cursor is on one of the menu groups.
- Returns the cursor to the menu input screen after changing menus.

6 RESET button (Remote control only)

Resets the parameter setting to the factory setting. (Items without factory settings cannot be reset.)

Basic menu operation

To ensure proper projection, start with setting and adjustment in menu group "SETUP".

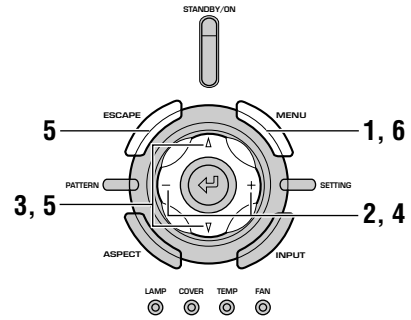
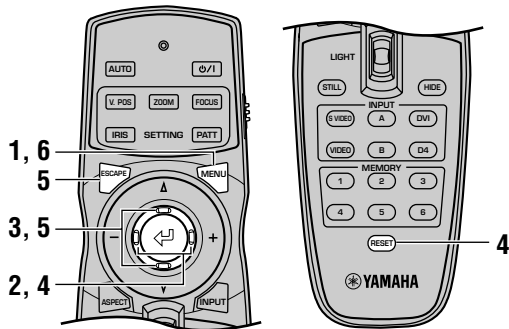

1. Press MENU to open the menu.

The previous menu screen opens if menu operations have already been performed.



or



Remote control

Control panel

Move Menu Window			
Image	Signal	Initial	Setup
Black Level	0	[Slider]	
White Level	0	[Slider]	
Gamma Trim	A B C D E	[Slider]	
Hue	0	[Slider]	
Saturation	100	[Slider]	
Color Temp.	6000K ±0.000uv	[Slider]	
Sharpness Type	Off L ML MH H	[Slider]	
Sharpness Gain	16	[Slider]	
Color Balance	Standard	[Slider]	
Level Adjustment		[Slider]	
Iris	Standard Cinema	[Slider]	
	Memory 1	VIDEO	

2. Press + or - to select a menu group.

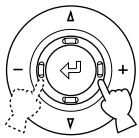

or

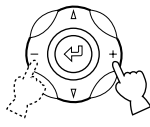

Remote control

Control panel

Move Menu Window			
Image	Signal	Initial	Setup
Location	Front / Table	[Slider]	
Keystone	0	[Slider]	
Remote Control Sensor	Front & Rear	[Slider]	
Remote Control ID	ID 1	[Slider]	
Lens Adjustment Lock	Off On	[Slider]	
White Boost	Off On	[Slider]	
Economy Mode	Off On	[Slider]	
Menu Color	Monotone	[Slider]	
Message	Off On	[Slider]	
Trigger Out	LAMP	[Slider]	
Baud Rate	115200bps	[Slider]	
	Memory 1	VIDEO	

3. Press ▽ to enter the menu item hierarchy.

Then select an item to be adjusted by pressing the △ or ▽ button.

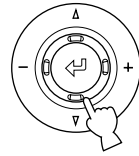

or

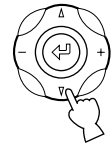

Remote control

Control panel

Move Menu Window			
Image	Signal	Initial	Setup
Location	Front / Table	[Slider]	
Keystone	0	[Slider]	
Remote Control Sensor	Front & Rear	[Slider]	
Remote Control ID	ID 1	[Slider]	
Lens Adjustment Lock	Off On	[Slider]	
White Boost	Off On	[Slider]	
Economy Mode	Off On	[Slider]	
Menu Color	Monotone	[Slider]	
Message	Off On	[Slider]	
Trigger Out	LAMP	[Slider]	
Baud Rate	115200bps	[Slider]	
	Memory 1	VIDEO	

4. Select or change the parameter by pressing + or -.

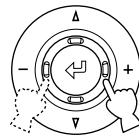

or

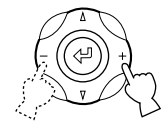

Remote control

Control panel

Move Menu Window			
Image	Signal	Initial	Setup
Location	Front / Table	[Slider]	
Keystone	0	[Slider]	
Remote Control Sensor	Front & Rear	[Slider]	
Remote Control ID	ID 1	[Slider]	
Lens Adjustment Lock	Off On	[Slider]	
White Boost	Off On	[Slider]	
Economy Mode	Off On	[Slider]	
Menu Color	Monotone	[Slider]	
Message	Off On	[Slider]	
Trigger Out	LAMP	[Slider]	
Baud Rate	115200bps	[Slider]	
	Memory 1	VIDEO	

Menu operation

Some items are adjusted by increasing or decreasing the value on the scale, and others by selecting a number or a word.



Press the **RESET** button to reset the parameter to the factory setting. (Items without a factory setting cannot be reset.)

5. Press Δ or ∇ to move the cursor to the next item.

To set a menu item in another menu group, press the **ESCAPE** or Δ button to return to the presently selected menu group, and follow steps 2—4 described previously to continue with menu setting.

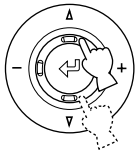

Remote control

or

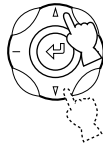

Control panel

6. Press MENU to close the menu when you have completed any changes.



Remote control

or



Control panel

Submenus

Following is a list of the menu items that have a submenu. Submenu operation varies according to the menu item selected. Follow the steps of the applicable submenu operation group.

Menu items with a submenu

Menu group	Menu item	Submenu operation group
IMAGE	COLOR TEMP.	A
	COLOR BALANCE	C
	LEVEL ADJUSTMENT	C
SIGNAL	DISPLAY ASPECT	A
	SIGNAL STATUS	A*
INITIAL	COLOR SYSTEM	B
	INPUT A SIGNAL	B
	INPUT A SYNC TYPE	B
	INPUT B SIGNAL	B
	INPUT B SYNC TYPE	B
	DVI SIGNAL	B
	DISPLAY LANGUAGE	A
	LAMP RUNNING TIME	D
	RESET	D
	SETUP	LOCATION
REMOTE CONTROL SENSOR		B
REMOTE CONTROL ID		B
MENU COLOR		A
TRIGGER OUT		A
BAUD RATE		A

Operation group A: Press the **+** or \leftarrow button to open the submenu. Select the desired parameter using the Δ or ∇ buttons (Δ , ∇ , **+**, or **-** buttons for COLOR TEMP.), then press the **ESCAPE** button to close the submenu.

*"SIGNAL STATUS" is a display-only message which does not alter any parameters.

Operation group B: Press the **+** or \leftarrow button to open the submenu. Select the desired parameter using the Δ or ∇ buttons, and press the \leftarrow button to confirm your setting. Press the **ESCAPE** button to close the submenu.

Operation group C: Press the **+** or \leftarrow button to open the submenu. Select the desired parameter using the Δ or ∇ buttons and then use the **+** or **-** buttons to change the parameters. It is not necessary to confirm the new setting.

Operation group D: Press the **+** or \leftarrow button to open the submenu. This submenu is in the form of messages. Follow the on-screen directions to adjust settings. The submenu for this group is explained on pages 26 and 27.

—EXCEPTION—

Some submenu items have further submenus attached to them. These items have " \rightarrow " displayed on the right. Press the \leftarrow button to enter the detail menu, and select an appropriate setting using the cursor keys.

■ Basic submenu operation

[Operation groups A and B]

1. Select the menu item to be adjusted by following steps 1—3 in “Basic menu operation”.

The submenu mark “↔” appears on the right side of the item.

Move Menu Window			
Image	Signal ↔	Initial	Setup
Display Aspect	↔	Auto	
3D Y/C Separation		Off	On
Noise Reduction		Off	1 2 3
Video Type		DVD	VCR
Progressive Mode		Auto	Video
Color Space Conversion		Auto	SDTV HDTV
Setup Level (SDTV)		0%	7.5%
Setup Level (HDTV)		0%	7.5%
Signal Status			
+ : Enter		Memory 1	VIDEO

2. Press + or ↵ to open the submenu.

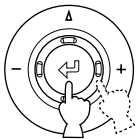

or

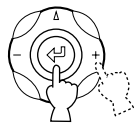

Remote control

Control panel

Move Menu Window			
Image	Signal ↔	Initial	Setup
Display Aspect	↔	Auto	
		Normal	
		Squeeze	
		Smart Zoom	
		Zoom	
		Subtitle Zoom	
		Through	
		Through Squeeze	
ESCAPE: Return		MEMORY 1	VIDEO

3. Select the submenu parameter by pressing Δ or ▽.

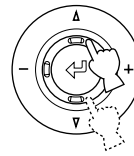

or

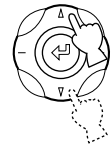

Remote control

Control panel

Move Menu Window			
Image	Signal ↔	Initial	Setup
Display Aspect	↔	Auto	
		Normal	
		Squeeze	
		Smart Zoom	
		Zoom	
		Subtitle Zoom	
		Through	
		Through Squeeze	
ESCAPE: Return		MEMORY 1	VIDEO

Press the **RESET** button to reset the parameter to the factory setting. (Items without a factory setting cannot be reset.)

The following step is necessary to set “COLOR SYSTEM”, “INPUT A SIGNAL”, “INPUT B SIGNAL”, “DVI SIGNAL” and “REMOTE CONTROL SENSOR” in operation group B.

[Operation group B only]

Press ↵ when setting is complete. This will confirm the new setting close the submenu. Settings for the above items will not be changed if not confirmed by the ↵ button.

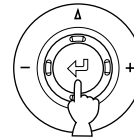

or



Remote control

Control panel

To reset the parameter to the factory setting, press the **RESET** button when the submenu has been opened.

4. Press MENU to close the menu.



or



Remote control

Control panel

Press the **ESCAPE** or – button to return to the previous screen and continue adjusting settings.

Menu operation

● Submenu operation — “COLOR BALANCE”

[Operation group C]

1. Follow steps 1—3 in “Basic menu operation” to select the menu item “COLOR BALANCE” in menu group <IMAGE>.

The submenu mark “↕” appears on the right side of the item.

Move Menu Window			
Image	Signal	Initial	Setup
Black Level	0	[Slider]	
White Level	0	[Slider]	
Gamma Trim	A B C D E	[Slider]	
Hue	0	[Slider]	
Saturation	100	[Slider]	
Color Temp.	6000K ±0.000uv	[Slider]	
Sharpness Type	Off L ML MH H	[Slider]	
Sharpness Gain	16	[Slider]	
Color Balance	↕	Standard	
Level Adjustment		[Slider]	
Iris	Standard Cinema	[Slider]	
+: Enter	Memory 1	VIDEO	

2. To set “RGBYCM” parameters, select “RGBYCM” with the ▾ button, and press the + button or ↵ to enter the submenu.

Move Menu Window			
Image	Signal	Initial	Setup
Color Balance	↕	Standard	
		RGB	
		RGBYCM	
+: Enter	Memory 1	VIDEO	

3. Select the submenu item by pressing △ or ▽.

Move Menu Window			
Image	Signal	Initial	Setup
R Color Coordinate		x=0.640 y=0.330	[Slider]
R Gain	0.96	[Slider]	
G Color Coordinate		x=0.300 y=0.600	[Slider]
G Gain	0.69	[Slider]	
B Color Coordinate		x=0.150 y=0.060	[Slider]
B Gain	0.43	[Slider]	
Y Color Coordinate		x=0.428 y=0.499	[Slider]
Y Gain	0.95	[Slider]	
C Color Coordinate		x=0.226 y=0.332	[Slider]
C Gain	0.68	[Slider]	
M Color Coordinate		x=0.336 y=0.163	[Slider]
M Gain	1.00	[Slider]	
ESCAPE: Return	Memory 1	VIDEO	

4. Use △, ▽, +, and – to set the gauge figures to your liking.

Press the **RESET** button to reset the parameter to the factory setting.

Move Menu Window			
Image	Signal	Initial	Setup
R Color Coordinate		x=0.640 y=0.330	[Slider]
R Gain	1.20	[Slider]	
G Color Coordinate		x=0.300 y=0.600	[Slider]
G Gain	0.69	[Slider]	
B Color Coordinate		x=0.150 y=0.060	[Slider]
B Gain	0.43	[Slider]	
Y Color Coordinate		x=0.428 y=0.499	[Slider]
Y Gain	0.95	[Slider]	
C Color Coordinate		x=0.226 y=0.332	[Slider]
C Gain	0.68	[Slider]	
M Color Coordinate		x=0.336 y=0.163	[Slider]
M Gain	1.00	[Slider]	
ESCAPE: Return	Memory 1	VIDEO	

5. Press **MENU** to close the menu.

To continue adjusting settings, press the **ESCAPE** button to return to the previous screen. Pressing the – button will not close the submenu.

● Submenu operation — resetting “LAMP RUNNING TIME”

[Operation group D]

1. Select the menu item “LAMP RUNNING TIME” in the menu group “INITIAL” by following steps 1—3 in “Basic menu operation”.

The submenu mark “↕” appears on the right side of the item.

Move Menu Window			
Image	Signal	Initial	Setup
Color System		Auto	
INPUT A Signal		Component	
INPUT A Sync Type		Auto	
INPUT B Signal		RGB PC	
INPUT B Sync Type		Auto	
DVI Signal		RGB PC	
Auto Power Off	Off	On	
Auto Input Search	Off	On	
Display Language		English	
Lamp Running Time	↕	0 Hour	
Reset		[Slider]	
+: Enter	Memory 1	VIDEO	

2. Press + or ↵ to open the confirmation message screen.

Move Menu Window			
Image	Signal	Initial	Setup
Press "↵" to reset lamp running time.			
<input type="button" value="No"/> <input checked="" type="button" value="Yes"/>			
Lamp Running Time		0 Hour	
↵: Fix	Memory 1	VIDEO	

3. Select "YES" with Δ or ∇ , and then press \leftarrow .

LAMP RUNNING TIME will reset to 0 hour.

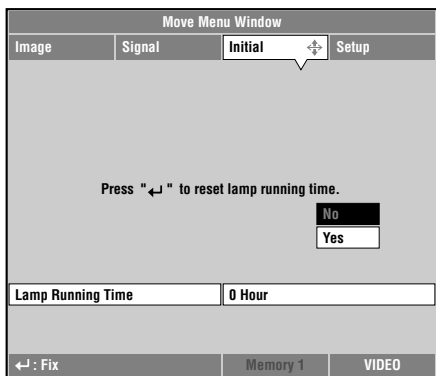

4. Press the MENU button to close the menu.

● Submenu operation—"RESET"

[Operation group D]

1. Follow steps 1—3 in "Basic menu operations" to select menu item "RESET" in menu group <INITIAL>.

The submenu mark "↕" appears on the right side of the item.

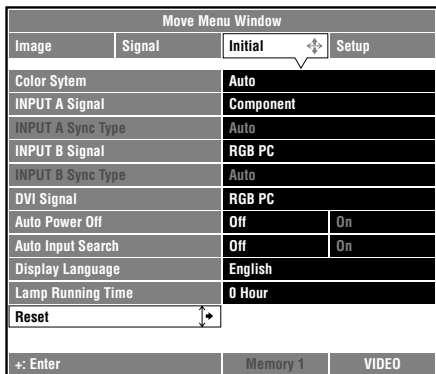

2. Press + or \leftarrow to open the submenu.

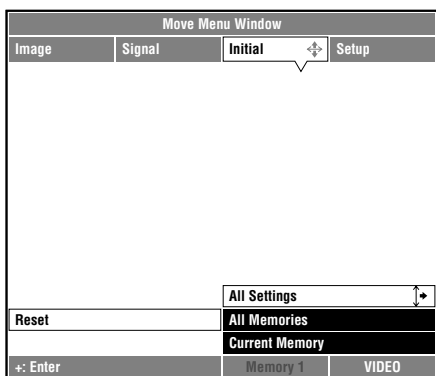

3. Press Δ or ∇ to select the submenu item to reset.

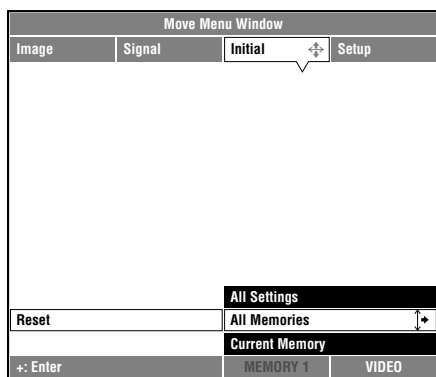

4. Press + or \leftarrow to open the confirmation message screen.

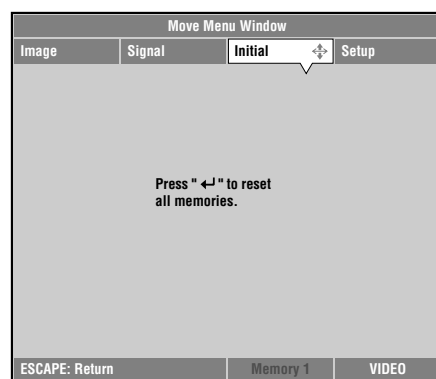

5. Press \leftarrow to reset the parameter to its factory default setting.

MENU

English

■ One-touch image menu

1. Press \leftarrow when the menu screen is not open.

Menu items appear one by one at the bottom of the screen. The display will disappear if no operation is performed within five seconds.

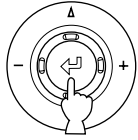

Remote control

or



Control panel



2. Press Δ or ∇ to select a menu item to adjust.

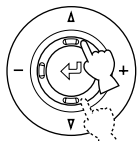

Remote control

or



Control panel



3. Press + or - to select the desired value.

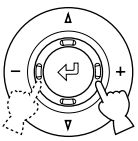

Remote control

or

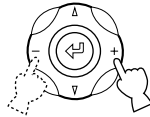

Control panel



Press the **RESET** button to reset the parameter to the factory setting.

4. Press ESCAPE to close the display.



Remote control

or



Control panel

■ Changing the menu location

1. Press ESCAPE or Δ to return the cursor to the menu group.

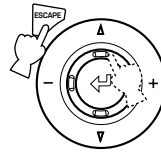

Remote control

or

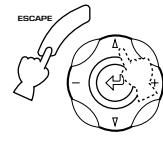

Control panel

Move Menu Window			
Image	Signal	Initial	Setup
Location		Front / Table	
Keystone		0	
Remote Control Sensor		Front & Rear	
Remote Control ID		ID 1	
Lens Adjustment Lock		Off	On
White Boost		Off	On
Economy Mode		Off	On
Menu Color		Monotone	
Message		Off	On
Trigger Out		LAMP	
Baud Rate		115200bps	
		Memory 1	VIDEO

2. Press Δ to enter the "MOVE MENU WINDOW".

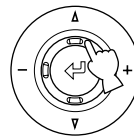

Remote control

or

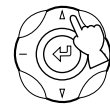

Control panel

Move Menu Window			
Image	Signal	Initial	Setup
▲			
+			
▼			
ESCAPE: Return		Memory 1	VIDEO

3. Press Δ , ∇ , +, or - to change the display location.

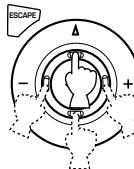

Remote control

or

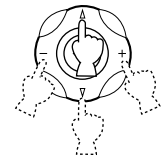

Control panel

4. Press ESCAPE to return to the menu after setting the location.



Remote control

or



Control panel

Memory function

This unit has a memory function able to store six settings for projecting different types of input sources in the most appropriate manner. Select the setting that is most appropriate for your projection. Some settings may not be available depending on the type of input signal currently in use. Six settings have been preset, but each parameter can be changed and restored at will. The following lists the menu items that you can store in memory.

IMAGE	SIGNAL
BLACK LEVEL (BRIGHTNESS)	3D Y/C SEPARATION
WHITE LEVEL (CONTRAST)	VIDEO TYPE
GAMMA TRIM	PROGRESSIVE MODE
SATURATION	COLOR SPACE CONVERSION
HUE	SETUP LEVEL
COLOR TEMP.	SIGNAL LEVEL
SHARPNESS TYPE	
SHARPNESS GAIN	
COLOR BALANCE	
LEVEL ADJUSTMENT	
IRIS	

■ Selecting the memory setting number

Using the remote control

Press the **MEMORY** button number with the desired setting. (MEMORY BUTTON 1—6)

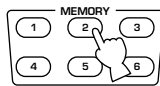

Using the menu

1. Press MENU to open the menu.



2. Press ▾ to enter the memory setting number at the bottom of the screen.

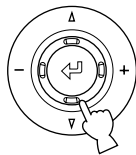

Move Menu Window			
Image	Signal	Initial	Setup
Display Aspect	Auto		
3D Y/C Separation	Off	On	
Noise Reduction	Off	1	2 3
Video Type	DVD	VCR	
Progressive Mode	Auto	Video	
Color Space Conversion	Auto	SDTV	HDTV
Setup Level (SDTV)	0%	7.5%	
Setup Level (HDTV)	0%	7.5%	
Signal Status			
+ : Enter			
Memory 1		VIDEO	

3. Press + to open the submenu.

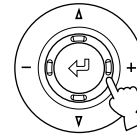

Move Menu Window			
Image	Signal	Initial	Setup
Memory 1 Memory 2 Memory 3 Memory 4 Memory 5 Memory 6			
ESCAPE: Return		Memory 6	VIDEO

4. Press △ or ▽ to select the number of the desired memory setting number.

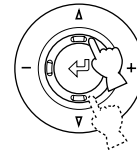

5. Press ESCAPE to close the submenu.



Resetting to the factory default settings

For one parameter

Follow steps 1—3 in “Basic menu operation” on page 23 to select the parameter to reset. Press the **RESET** button on the remote control to return the parameter to its factory default setting. (Items without a factory default cannot be reset.)

To reset all parameters for the currently selected memory number

Follow the directions in “Submenu operation—RESET” on page 27 to select “CURRENT MEMORY” on the submenu. Press the + or ↵ buttons to open the confirmation message screen. Press the ↵ button to reset the selected memory area to its factory default settings.

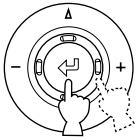

or

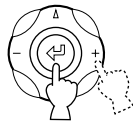

Remote control

Control panel

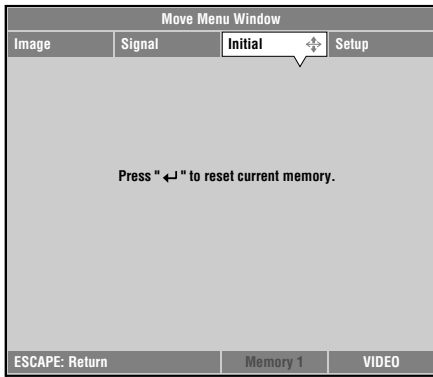

To reset all parameters in all six memory settings

Follow the directions in “Submenu operation—RESET” on page 27 to select “ALL MEMORIES” on the submenu. Press the + or ↵ buttons to open the confirmation message screen. Press the ↵ button to reset to factory default settings.

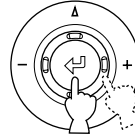

or

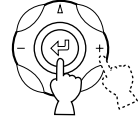

Remote control

Control panel

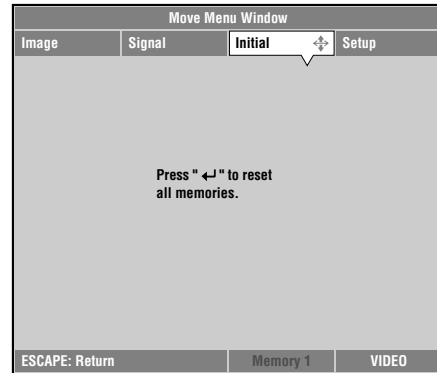

Additional information

■ Glossary

The following is a list of key words and their explanations used in the use of projectors and image signals. Please refer to it when using the DPX-1000.

DLP™ technology

This stands for Digital Light Processing. DLP uses the DMD™ chip, developed by Texas Instruments.

DCDi™ function

This is an abbreviation of Directional Correlational Deinterlacing, a high quality image circuitry developed by the Faroudja company. It uses edge cutting techniques to remove jagged edges from images during Interlace → Progressive conversion, allowing smooth, natural image reproduction.

Component video signal

Component video signal is sent with independent luminance and color signals. It gives a higher image quality than ordinary composite video signal because it bypasses mixing and separating circuits. Component video signal consists of three lines, the luminance signal (Y) and two color difference signals (Pb/Cb, Pr/Cr).

S video signal

S stands for Separate. This signal is sent with separated luminance (Y) and color (C) signals. Use a 4-pin mini DIN connector and cable for connection.

Composite video signal

This is the most common type of video signal. The luminance signal and color signal are sent combined in one line. Mixing and separating processes are necessary on both the send and receive sides. A pin cable is used for connection.

RGB signal

An RGB signal transmits color information by using a numeric representation of the primary colors of red, green and blue separately. When the signal is received, it can be expressed in various colors by adding and mixing colors. This type of signal is widely used for sending and receiving color images between computers. Horizontal and vertical sync signals are also necessary.

HDTV

This is an abbreviation of High-Definition Television, a term used to define systems that satisfy the following conditions:

- A vertical resolution of 720p, or 1080i (p stands for progressive scans, i stands for interlace scans).
- An image aspect ratio of 16:9

SDTV

An abbreviation of Standard Definition Television, used to define normal television broadcasts which do not meet the standards of HDTV.

D connector

This connector is designed for the Japanese D format only. It is used for sending and receiving the image signal between the latest type of A/V components. This connector can receive the component signal by using a D connector cable. There are five levels (D1—D5) of performance characteristics. This unit is compatible with D1, 2, 3, and 4.

DVI connector

A digital RGB/Component signal is sent differentially from a computer or A/V equipment to this connector. A 24-pin connector and cable are used.

Standby

The state in which the circuit to receive infrared-signals from the remote control is activated but other main circuits are turned off. A small amount of power is consumed in this state.

Test pattern

Test patterns are stored in this unit for use in adjusting the position and focus of the projected image on the screen.

Interlace

The most common type of scanning in use in televisions. It divides an image into two fields for scanning, and uses even and odd numbered lines of those fields to build an image (frame).

Progressive

This displays all the scanning lines of the entire frame at one time. It greatly reduces the flicker that is more noticeable on a larger screen to create a sharp and smooth image. This unit projects using progressive scanning.

3-2 Pulldown detection style IP conversion

A function for directly converting interlace signal into sixty frame progressive signal used when receiving 60 field interlace signal from an image source recorded with the same 24 frames as movie film. This allows DVD and other materiel recorded with 24 frames to be projected on large screens as a natural, precise image with no loss of quality, comparable to a movie film.

SYNC

Computers output signals with a given regular frequency, which the projector must be synchronized to in order to produce a good quality image. Failure to match the phase of the signal will result in flickering, fading, and distortion of the image.

TRACKING

Computers output signals with a given regular frequency, which the projector must be synchronized to in order to produce a good quality image. Failure to match signal frequencies will result in vertical striping in the image.

- DLP™ and DMD™ are trademarks of Texas Instruments.
- **DCDi** is a trademark of Faroudja, a division of Genesis Microchip Inc.

Additional information

HDCP

High-bandwidth Digital Content Protection system. HDCP is designed to protect the video transmission between a DVI transmitter and a display device.

Aspect

This refers to the length-to-width ratio of an image.

Ceiling mount bracket

This is the mounting hardware used to hand this unit from the ceiling. Two types of bracket are available, for high and low ceilings. Ceiling mount brackets are sold separately.

Keystone

If the unit is used at an angle to the screen the projected image will be distorted in a trapezoid fashion. Keystone is used to electronically correct this distortion.

Letter box

This is a method used to convert the content of a film in landscape orientation to a 4:3 signal. It is possible to watch a landscape image without trimming by adding a black bar to the top and bottom of the screen, however this sacrifices vertical resolution to some extent.

Squeeze

This method compresses a film image horizontally to an aspect ratio of 4:3 when recording on a video medium. The squeezed image must pass through a de-squeezing circuit in order to be projected in its original form.

Smart Zoom

Smart zoom expands the left and right sides of a 4:3 image without altering the center, when it is necessary to project a 4:3 image to a wide screen format. This creates some distortion at both edges.

Vista size

A standard film size. The aspect ratio is 1.85:1 in North America and 1.66:1 in Europe.

Cinema scope size

The widest film format in 70mm film. The aspect ratio is 2.35:1.

Color spacing

This refers to the conversion of YUV color separated signal to RGB signal. There are two formats for this, SDTV BT.601 and HDTV BT.709. This unit can switch between them as required.

■ Projectable signals

The following charts show the types and formats of the signals that can be projected by this unit. Any signals not listed below may not be properly projected.

1. TV format ① ----- Composite or S video signals sent to the VIDEO or S-VIDEO inputs

Type of signal	V active (lines)	f (v) (Hz)	fsc (MHz)	Color system
NTSC	480	59.94	3.58	NTSC
PAL	576	50.00	4.43	PAL
SECAM	576	50.00	4.406, 4.25	SECAM
PAL60	480	59.94	4.43	PAL
NTSC4.43	576	59.94	4.43	NTSC
PAL-M	480	59.94	3.58	PAL
PAL-N	576	50.00	3.58	PAL

2. TV format ② ----- Component or RGB TV signals sent to the INPUT A, B and DVI, or component signals sent to the D4, DVI input connector

Type of signal	H active (pixels)	V active (lines)	f (H) (kHz)	f (V) (Hz)
480i*	720	483	15.734	59.940
576i*	720	576	15.625	50.000
480p	720	480	31.469	59.940
576p	720	576	31.250	50.000
720p/50Hz	1280	720	37.500	50.000
720p/60Hz	1280	720	45.000	59.940
1035i*	1920	1035	33.750	60.000
1080i/50Hz	1920	1080	28.125	50.000
1080i/60Hz	1920	1080	33.716	59.940

- DVI digital component format supports YCbCr 4:4:4 (8 bit x 3) only.

* This unit does not support these signal types when using a DVI connection.

3. PC format ① ----- Analog RGB PC signals sent to the INPUT A or B inputs

	Type of signal	H active (pixels)	V active (lines)	f (H) (kHz)	f (V) (Hz)
VESA	VGA/60Hz	640	480	31.469	59.940
	VGA/72Hz	640	480	37.861	72.809
	VGA/75Hz	640	480	37.500	75.000
	VGA/85Hz	640	480	43.269	85.008
	SVGA/56Hz	800	600	35.156	56.250
	SVGA/60Hz	800	600	37.879	60.317
	SVGA/72Hz	800	600	48.077	72.188
	SVGA/75Hz	800	600	46.875	75.000
	SVGA/85Hz	800	600	53.674	85.061
	XGA/60Hz	1024	768	48.363	60.004
Apple	Mac13"	640	480	35.000	66.666

- VESA is trademark of Video Electronics Standards Association.
- Macintosh is a trademark of Apple Computer, Inc.

4. PC format ② ----- Digital RGB signal input sent to the DVI input terminal

Depending on the computer you are using, projection may not be possible in this mode.

	Type of signal	H active (pixels)	V active (lines)	f (H) (kHz)	f (V) (Hz)
VESA	VGA/60Hz	640	480	31.469	59.940
	SVGA/60Hz	800	600	37.879	60.317
	XGA/60Hz	1024	768	48.363	60.004
	1280x720/60Hz	1280	720	45.000	59.940

■ Message display

Message	Condition
No Signal	The unit is not receiving or detecting any signal at the selected input source. This message is displayed together with the name of the input source selected with the INPUT button.
INPUT A (Component) (Example)	The input name selected by the INPUT button is displayed. It will turn off 1 minute after the signal has been input.
Out Of Range	The unit is not able to decode the PC signal currently being input.
Unknown Format	The unit is not able to decode the video signal currently being input.
Auto Sync...	The unit is setting itself to the most appropriate configuration for the RGB signal currently being received.
Memory 1—6	The memory setting number is displayed for 2 seconds.
The lamp needs to be replaced. Please replace the lamp you are currently using with a new one.	This message is displayed when the power switch is turned on if the lamp running time exceeds 2000 hours. Press the ESCAPE key to remove the message.
Press again for standby.	Press the STANDBY/ON button once more to place the unit in standby mode.
Squeeze (Example)	The name of the display aspect mode selected with the ASPECT button is displayed for 2 seconds.
Lens Adjustment is locked.	Displayed when the “LENS ADJUSTMENT LOCK” is set to “ON”. This message will display for 2 seconds if you press the V. POS, ZOOM, or FOCUS buttons when the “LENS ADJUSTMENT LOCK” is set to “ON”.

Maintenance

■ Regular care

Be sure to disconnect the power cable prior to doing any maintenance.

<MAIN UNIT>

Wipe with a soft cloth. Use a damp cloth with a mild detergent and then wipe with a dry cloth again if the unit is heavily soiled. Do not use strong solvents such as thinner or alcohol as they may damage the case of this unit.

<LENS>

Use commercially available blowers or lens tissue to remove any dirt from the lens.

<FILTER>

If dust is allowed to accumulate on the ventilation port filter, the internal temperature of the unit will rise which may cause damage to the unit. Clean the filter approximately once every 200 hours. Remove the power cable from the power outlet, and remove dust from the filter with a vacuum cleaner.

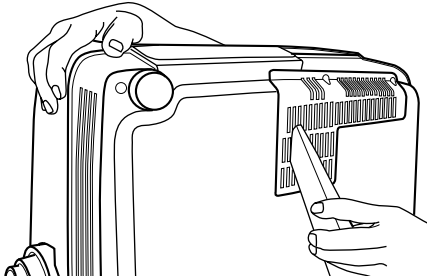

Be sure to vacuum the filter with the unit on its side, in order to prevent dust from entering the filter itself.

■ Filter replacement

Replace the filter when it becomes difficult to remove dust from it.

- 1. Turn off the power and disconnect the power cable from this unit.**
- 2. Carefully place the unit upside down on a soft cloth to prevent scratching.**
- 3. Press the filter hook on the underside of the main unit to remove the filter.**

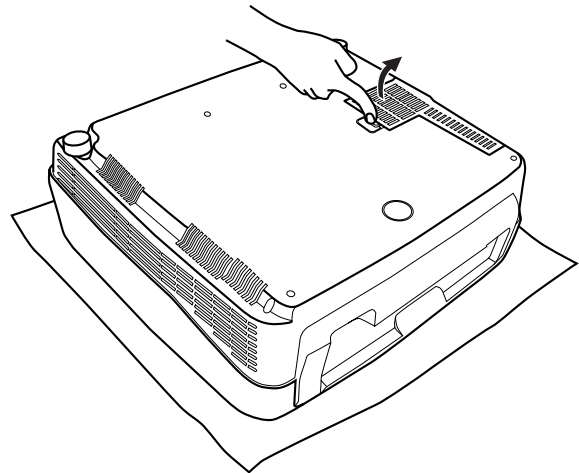

- 4. Attach the new filter firmly. The lamp will not light if the filter is not attached correctly.**

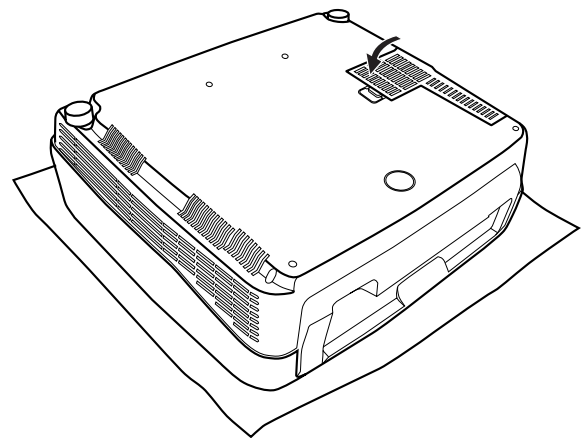

Important

- Contact a YAMAHA dealer or service center if you require replacement filters.

■ Replacing the lamp cartridge

Important

- Be sure to use the replacement lamp cartridge P JL 327. Other lamp cartridges are not suitable for use in this unit.

The lamp used as a light source in this unit is a consumable and will gradually lose its brightness during the course of use. It is advisable to replace the lamp when running time has exceeded 2000 hours.

You can view the current lamp running time in ③ <INITIAL> on the menu. The LAMP warning indicator will blink when running time exceeds 2000 hours. (See page 15.)

There will also be a message displayed on the screen. In this case, follow the instructions below to replace the lamp cartridge. Be sure to use the replacement lamp cartridge P JL 327. Other lamp cartridges are not suitable for use in this unit. Consult the store where this unit was bought for details on replacement lamp cartridges.

Important

- Before starting to replace the lamp cartridge, turn off the power, disconnect the power cable after the fan has completely stopped, and wait at least one hour for the lamp to cool down.
- Do not remove any other screws than those specified in the following steps.

1. Loosen the lamp cover screws.

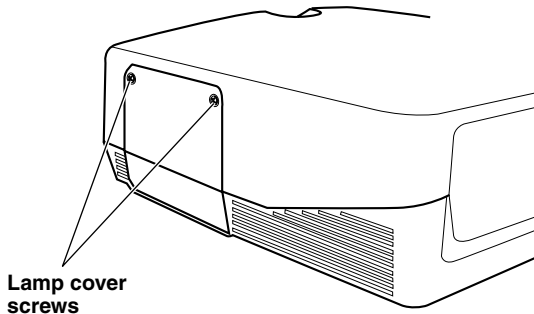

2. Remove the lamp cover.

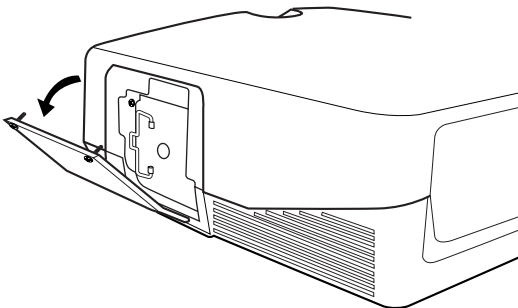

Important

- Take care not to drop the lamp or cover when replacing a lamp in a ceiling mounted unit.

3. Loosen the screws of the lamp cartridge.

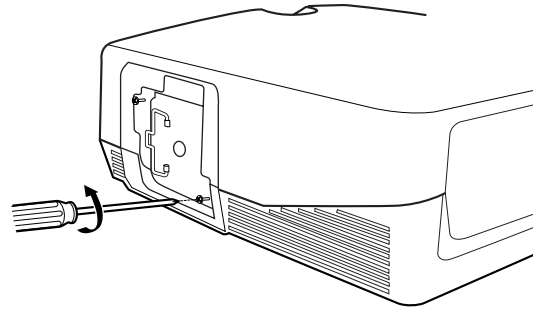

4. Grip the handle and pull the lamp cartridge to remove it.

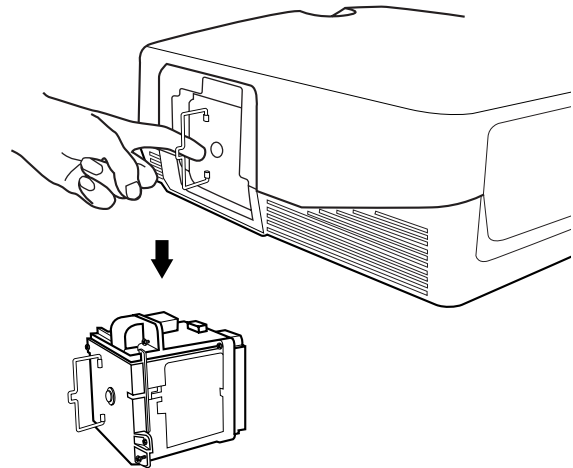

5. Insert the new lamp cartridge by reversing the above steps, and tighten the screws to fix it into place.

6. Replace the lamp cover and secure it with the screws.

The lamp will not turn on if the cover is not securely fastened. Take care to attach it firmly in place.

7. Connect the unit to the power outlet, turn the unit on, and reset "LAMP RUNNING TIME" on the ③ <INITIAL> section in the menu. (See page 20.)

Troubleshooting

Refer to the chart below when this unit does not function properly. If the problem you are experiencing is not listed below or if the instruction below does not help, set this unit in the standby mode, disconnect the power cord, and contact the nearest authorized YAMAHA dealer or service center.

Problem	Cause	Remedy
This unit does not turn on.	The power cable is not plugged in.	Plug the power cable in firmly.
	You attempted to turn on this unit immediately after turning it off.	In order to protect the lamp, the unit will not turn on again for 2 minutes after the power is turned off.
	The filter cover is not correctly attached.	Correctly attach the filter cover.
	The lamp cover is not correctly attached.	Correctly attach the lamp cover.
No picture	The lens cover has not been removed.	Remove the lens cover.
	This unit is not correctly connected to the other components.	Check the connections.
	The input signal has not been correctly selected.	Select the correct input signal with the INPUT button.
		Press the AUTO button.
		Use the menu to adjust the signal setting to suit the input setting.
The picture is turned off.	Press the HIDE button again to cancel the HIDE function.	
The computer is not set to display on the external monitor.	Set the computer to display on the external monitor. (Refer to the computer operating instructions.)	
Image is unstable.	The connection cables are not correctly attached to the connectors.	Correctly connect the cables to the appropriate connectors.
Picture is blurred.	The lens is not correctly focused.	Press the FOCUS button, and adjust the focus.
	The screen and the main unit are not facing each other directly.	Adjust the projection angle and direction, and the height of this unit.
The image becomes cloudy.	There is condensation on the unit.	Switch the unit power off until the condensation disappears.
Cannot adjust focus or zoom, or the vertical position of the lens.	“LENS ADJUSTMENT LOCK” in the menu is set to ON.	Set “LENS ADJUSTMENT LOCK” to OFF.
Remote control does not work correctly.	The batteries are exhausted.	Replace both batteries with new ones.
	The remote control sensor is not set correctly.	Select an appropriate remote control sensor from the menu.
	There is a fluorescent lamp near the remote control sensor being used.	Turn off this remote sensor.
	The remote control code switch is incorrectly set.	Set the remote control code switch to the same ID number as the setting on the “REMOTE CONTROL ID” in the setting menu.
COVER warning indicator lights up.	The filter cover is not correctly attached.	Tightly attach the filter cover.
	The lamp cover is not correctly attached.	Tightly attach the lamp cover.
LAMP warning indicator lights up or blinks.	Lamp running time has exceeded 2000 hours.	Replace the lamp with a new one.
	The lamp has burned out.	Replace the lamp with a new one.
TEMP warning indicator lights up.	The temperature inside this unit is extremely high.	Check that the ventilation slots are not covered.
FAN warning indicator lights up.	The fan is broken.	Contact the store where this unit was purchased.

Specifications

■ Specifications

Optical

Projection mode	DLP™ (Digital Light Processing) Images of 1280 x 720 pixels, 0.8 inch
Lens	f=24.4 to 39 mm F=2.4 to 3.1 Electronic zoom (x 1.6) Electronic focus
Lamp	270 W SHP lamp
Image size	60 to 200 inches Projection distance 1.8 to 6.05 m (70"7/8 to 236"1/5) (Wide image, 16:9 screen)
Brightness	800 ANSI lm (Standard mode) 500 ANSI lm (Cinema mode)
Contrast	1500:1 (Standard mode) 2700:1 (Cinema mode)

Electrical

Color mode	NTSC, PAL, SECAM, NTSC ^{4.43} , PAL-M, PAL-N, PAL60
Scanning frequency	H:15 to 54 kHz/V; 50 to 85 Hz (Analog) 50 to 60 Hz (Digital)

Input

VIDEO	Composite signal 1Vp-p/75Ω, negative sync.
S VIDEO	S video signal Y: 1Vp-p/75Ω, negative sync. C: 0.286 or 0.3Vp-p/75Ω
D4 VIDEO	Component signal Y with sync.: 1Vp-p/75Ω, negative sync. (480i, 576i, 480p, 576p) Y with sync.: 1Vp-p/75Ω, 3 values sync. (1035i, 1080i, 720p) Pb, Pr: 0.7Vp-p/75Ω
INPUT A/INPUT B	Component signal Y with sync.: 1Vp-p/75Ω, negative sync. (480i, 576i, 480p, 576p) Y with sync.: 1Vp-p/75Ω, 3 values sync. (1035i, 1080i, 720p) Pb, Pr: 0.7Vp-p/75Ω RGB signal G with sync.: 1Vp-p/75Ω, negative sync. (480i, 576i, 480p, 576p) G with sync.: 1Vp-p/75Ω, 3 values sync. (1035i, 1080i, 720p) G: 0.7Vp-p/75Ω (when using HD/VD or SYNC) B, R: 0.7Vp-p/75Ω HD, VD: 1 to 5 Vp-p/2.2 kΩ, positive and negative sync. SYNC: 2Vp-p/2.2kΩ, negative sync. (480i, 576i) SYNC: 1 to 5 Vp-p/2.2kΩ, positive and negative sync. (480i, 576i, 480p, 576p)
DVI	Digital RGB/Component signal

Controls

Remote	RS-232C (D-Sub 9 pin)
Trigger	+12 V/Maximum 200 mA when the power is on; 0 V when the power is off (mini jack)

Remote control sensor

Wireless remote control	one in front and one at rear
Wired remote control	one input jack one output jack

General

Usable temperature range	5°C to 35°C
Usable humidity range	30% to 85% (There should be no condensation.)
Power supply	AC 100 to 120 V/220 to 240 V, 50/60 Hz
Power consumption	365 W Standby mode 0.1 W
Noise Level	30 db (Standard mode) 28 db (Economy mode)
Dimension	495 (W) x 189.5 (H) x 465.4 (D) mm 19"-1/2 (W) x 7"-1/2 (H) x 18"-5/16 (D) inch
Weight	13.8 kg (30 lbs 7 oz)

* Specifications are subject to change without notice.

This unit may interfere with reception if placed in close proximity to a radio or television receiver. Follow the instructions in this manual to install the unit correctly.

■ Dimensional drawing

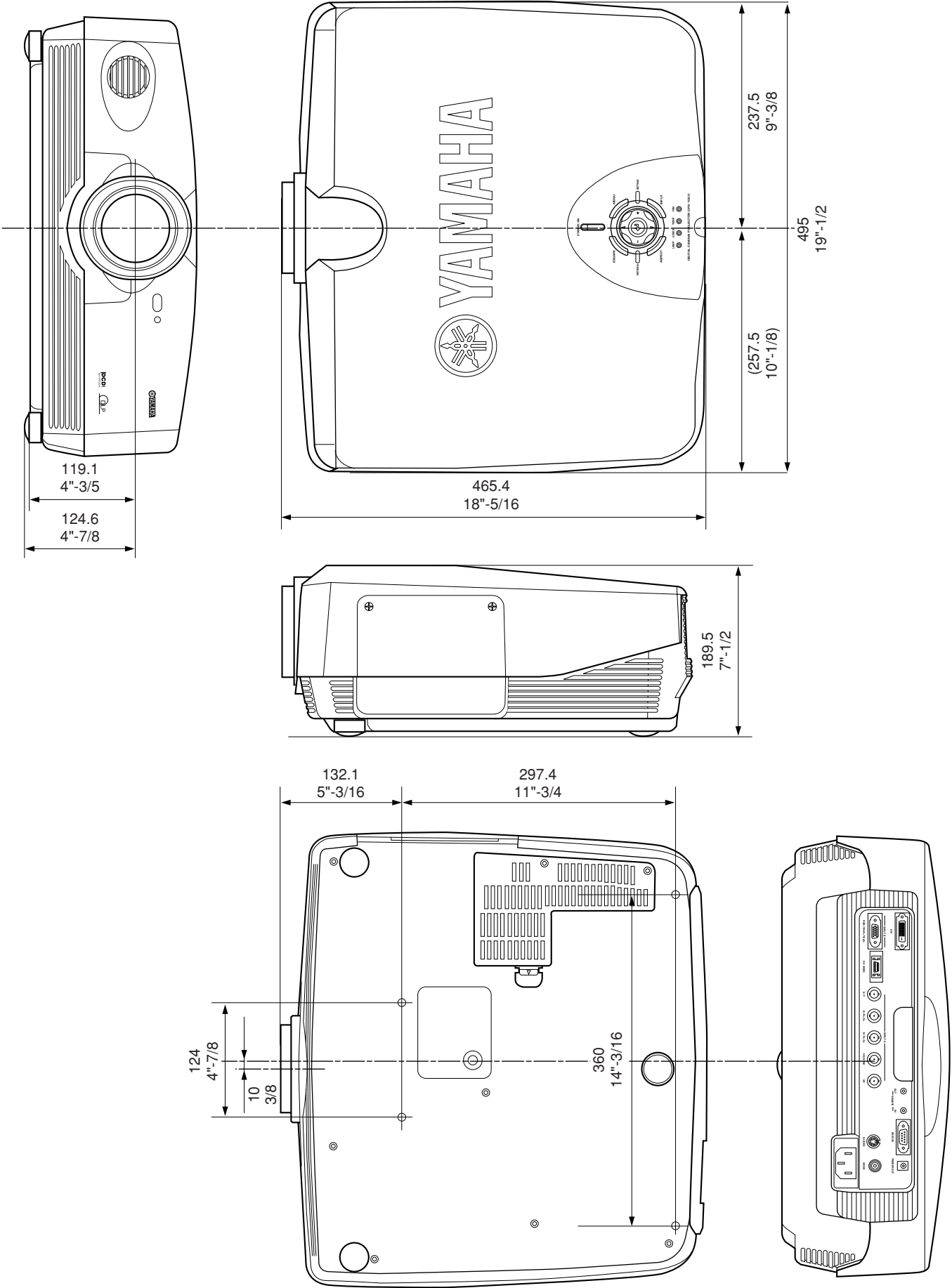

ADDITIONAL INFORMATION

English



YAMAHA ELECTRONICS CORPORATION, USA 6660 ORANGETHORPE AVE., BUENA PARK, CALIF. 90620, U.S.A.
YAMAHA CANADA MUSIC LTD. 135 MILNER AVE., SCARBOROUGH, ONTARIO M1S 3R1, CANADA
YAMAHA ELECTRONIK EUROPA G.m.b.H. SIEMENSSTR. 22-34, 25462 RELLINGEN BEI HAMBURG, F.R. OF GERMANY
YAMAHA ELECTRONIQUE FRANCE S.A. RUE AMBROISE CROIZAT BP70 CROISSY-BEAUBOURG 77312 MARNE-LA-VALLEE CEDEX02, FRANCE
YAMAHA ELECTRONICS (UK) LTD. YAMAHA HOUSE, 200 RICKMANSWORTH ROAD WATFORD, HERTS WD1 7JS, ENGLAND
YAMAHA SCANDINAVIA A.B. J A WETTERGRENS GATA 1, BOX 30053, 400 43 VÄSTRA FRÖLUNDA, SWEDEN
YAMAHA MUSIC AUSTRALIA PTY, LTD. 17-33 MARKET ST., SOUTH MELBOURNE, 3205 VIC., AUSTRALIA

YAMAHA CORPORATION
Printed in Japan  WA66190